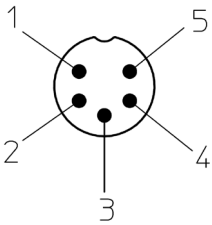
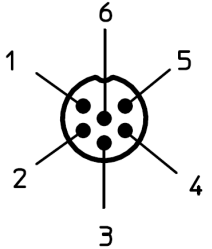
	<h2>HySense QG2xx</h2>	
	<p>Präziser Zahnrad-Durchflusssensor nach dem Verdrängerprinzip mit Anschluss über Anschlussplatte seitlich oder von unten.</p> <ul style="list-style-type: none"> • Geringe Viskositätsabhängigkeit • Weiter Messbereich • Schnell austauschbar, aufgrund der Plattenbauweise • Keine Rohrmontage notwendig 	<p><i>Precise Gear flow meter according to displacement with connection via connector plate from the side or from below.</i></p> <ul style="list-style-type: none"> • <i>Small viscosity dependence</i> • <i>Wide measuring range</i> • <i>Quick replaceable, because of plate construction</i> • <i>No pipe installation necessary</i>
<p>Beschreibung <i>description</i></p>	<p>Zwei ineinandergreifende Zahnräder werden durch die Strömungsenergie des durchströmenden Mediums in Rotation versetzt, wobei die Flüssigkeitsmenge zwischen der Gehäusewandung und den Zahnflanken transportiert wird. Anhand der gemessenen Frequenz wird der vorhandene Volumenstrom ermittelt.</p> <p>Der Zahnrad-Volumenstromsensor wird werkseitig für Mineralöl bei 30mm²/s in Durchflussrichtung (siehe Typenschild) kalibriert, optional sind andere Kalibrier-viskositäten oder eine Kalibrierung in beide Richtungen möglich.</p>	<p><i>Two meshing gears are rotated by the flow energy of the medium, the amount of liquid is transferred between the housing and flank of tooth. Based on the measured frequency the correct flow rate is determined.</i></p> <p><i>By default the GFM are measured and calibrated in flow direction (see label) for mineral oil at 30mm²/s, optionally other calibration viscosities or a calibration in both directions are possible.</i></p>
<p>Eigenschaften <i>qualities</i></p>	<ul style="list-style-type: none"> • Durchflussbereiche von 0.005 bis 120 l/min • Messbereiche bis 1:1000 • Viskositätsbereich 5...300 cSt • Messgenauigkeit bis ±0.3 % • Mengenummessung möglich • Hohe Viskositätsunabhängigkeit • Gute Reproduzierbarkeit • Hohe Auflösung • Hohe Arbeitsdrücke • Kurze Ansprechzeit • Erkennung der Durchflussrichtung • Beliebige Einbaulage 	<ul style="list-style-type: none"> • <i>Volume flow range from 0.005 to 120 l/min</i> • <i>Ranges up to 1:1000</i> • <i>Viscosity range 5...300 cSt</i> • <i>Accuracy up to ±0.3 %</i> • <i>Volume measurement possible</i> • <i>High viscosity independence</i> • <i>Good reproducibility</i> • <i>High resolution</i> • <i>High working pressures</i> • <i>Short response time</i> • <i>Detection of flow direction</i> • <i>detection</i> • <i>Any mounting position</i>

Verwendungszweck <i>designated use</i>	<p>Zum Messen von Volumenströmen in stationären sowie mobilen Hydraulikanlagen.</p> <p>In Verwendung mit flüssigen Medien der Gruppe 2 gemäß Klassifizierung der Druckgeräte-richtlinie 2014/68/EU (ungefährliche Fluide).</p> <p>Geeignet für Prüfstände von Pumpen und Motoren, Positionierung von Zylindern oder zum Abfüllen und Dosieren.</p>	<p><i>For measuring flow rates in stationary and mobile hydraulic systems.</i></p> <p><i>Use in fluid circuits working with fluids of group 2 according to the classifications of the Pressure Equipment Directive 2014/68/EU (non dangerous fluids).</i></p> <p><i>Suitable for test benches for pumps and motors, positioning of cylinders or for filling and dispensing.</i></p>
Einbauhinweise <i>installation instructions</i>	<ul style="list-style-type: none"> • Einbaulage beliebig, standardmäßige Strömung in Pfeilrichtung • Vor dem Einbau Anlage durch gründliches Spülen von Verunreinigungen befreien • Keine Schmutzpartikel >25µm im Messmedium • Nach dem Einbau langsam mit Betriebsmittel füllen und Leitungen entlüften • Starke Querschnittsänderungen in der Einlaufstrecke vermeiden • Keine Faserdichtungen verwenden, Gewindedichtmittel für Anschlussstücke verwenden (z.B. Loctite 577) 	<ul style="list-style-type: none"> • <i>Any mounting position possible, flow in direction of arrow as standard</i> • <i>Before mounting clean system by thorough rinsing of contaminants</i> • <i>No particles >25µm in the medium</i> • <i>After mounting please fill slowly with the operating medium and vent the pipes</i> • <i>Avoid strong cross-sectional changes in the inlet zone</i> • <i>Don't use fiber gasket, use thread gasket for fittings (for example Loctite 577)</i>
Gebrauchshinweise <i>note for use</i>	<ul style="list-style-type: none"> • Nicht mit Wasser, Luft oder Gasen als Messmedium verwenden • Es dürfen sich keine Luftblasen im Hydrauliksystem befinden • Druckschläge auf den Zahnrad-Volumenstromsensor vermeiden • Schnellen Richtungswechsel des Messmediums vermeiden • Nicht mit Pressluft ausblasen 	<ul style="list-style-type: none"> • <i>Do not use with water, air or gas as the measuring medium</i> • <i>There must be no air bubbles in the hydraulic system</i> • <i>Avoid pressure shocks to the gear flow meter</i> • <i>Avoid rapid changes in direction of the medium</i> • <i>Don't clean with compressed air</i>

Hinweis zur Produktwahl <i>note for product choice</i>	<p>Für einen sicheren und störungs-freien Betrieb der Volumensensoren ist die richtige Auswahl (Auslegung) von Typ und Baugröße entscheidend. Aufgrund verschiedener Anwendungen und Volumensensorausführungen sind die technischen Daten im Datenblatt allgemeiner Art. Bestimmte Eigenschaften der Geräte sind abhängig von Typ, Baugröße und Messbereich, sowie von der zu messenden Flüssigkeit. Für eine exakte Auslegung setzen sie sich bitte direkt mit HYDROTECHNIK GmbH in Verbindung.</p>	<p><i>For safe and trouble-free operation of the flow meters the correct selection (interpretation) of type and size is critical. Because of the various applications and flow sensor designs, the specifications in the datasheet are of a general nature. Certain properties of the devices depend on type, size and range, as well as of the measured liquid. For an accurate interpretation, please contact HYDROTECHNIK GmbH directly.</i></p>
--	--	---

Pinbelegungen <i>Pin assignments</i>	Bezeichnung <i>Labeling</i>	Nr. No	Funktion	Function
Rundsteckverbinder M 16 x 0.75 mit Schraubverriegelung, Ausführung 05-a, 5-polig, Stecker <i>Circular connectors M16 x 0.75 with screw-locking Layout 05-a, 5 poles, male IEC / DIN EN 61076-2-106</i>				
 <p>M16 5p m</p>	Ausgangssignal Frequenz , frequency			
	f-signal	1	Frequenzsignal f-signal	<i>frequency signal f-signal</i>
	GND Ub / Signal	2	Versorgung- und Signalmasse	<i>Supply and signal ground</i>
	+Ub	3	Versorgung +	<i>Supply +</i>
	f-signal2	4	Frequenzsignal f-signal (Richtung)	<i>frequency signal f-signal (direction)</i>
nc	5	nicht verbunden	<i>not connected</i>	
Rundsteckverbinder M16 x 0.75 mit Schraubverriegelung, Ausführung 06-a, 6-polig, Stecker <i>Circular connectors M16 x 0.75 with screw-locking, Layout 06-a, 6 poles, male IEC / DIN EN 61076-2-106</i>				
 <p>M16 6p m</p>	Ausgangssignal Strom , current			
	Signal	1	Signal+	<i>signal+</i>
	GND	2	Masse	<i>Ground</i>
	+Ub	3	Versorgungsspannung	<i>Supply voltage</i>
	Switch	4	Schaltsignal	<i>Switching level</i>
	Shield	5	Schirmung	<i>Shielding</i>
ISDS	6	Sensorerkennung	<i>Sensor detection</i>	

Richtungserkennung flow direction

In Durchflussrichtung
In flow direction

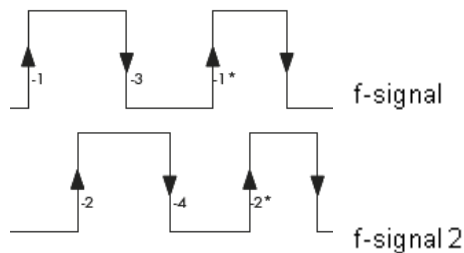

Mit Hilfe des f-signal2 kann die Durchflussrichtung (siehe auch Typenschild) erkannt werden. Das f-signal2 ist, zum vorausgehenden f-signal, um 90° phasenverschoben. Bei entgegengesetzter Durchflussrichtung wird f-signal2 zum vorausgehenden Signal.

The f-signal 2 indicates the flow direction (see also type plate). There is a 90° phase displacement between f-signal 2 and f-signal. In flow direction f-signal is the prior signal followed by f-signal 2. In case of different flow direction f-signal will follow f-signal 2.

Bei Verwendung von Hydrotechnik Messgeräten wird über die Option Richtungserkennung die Durchflussrichtung mit positivem Vorzeichen dargestellt.

Using Hydrotechnik handhels the flow direction will be indicated with a positive sign if using the signal type "with direct."

Eigenschaften properties	Referenzbedingungen / Reference conditions: Umgebungstemperatur Ta = 25°C / environmental temperature Ta = 77°F			
Parameter parameter	Min	Max	Einheit units	Bemerkung remarks
Durchflussbereich <i>flow range</i>	0.005...2L/min 0.01...10L/min 0.03...40L/min 0.2...120L/min		L/min	Einschränkung des Messbereiches und Verbesserung der Genauigkeit - auf Anfrage <i>Flow range limitation and increasing accuracy - on request</i>
Viskositätsbereich <i>viscosity range</i>	5	300	cSt mm ² /s	höhere Viskosität - auf Anfrage <i>higher viscosity - on request</i>
Standard Kalibrierviskosität <i>standard calibration viscosity</i>	30		cSt mm ² /s	andere Viskositäten - auf Anfrage <i>different viscosity - on request</i>
zulässiger Betriebsdruck max. <i>operating pressure max.</i>		450	bar	P _N
Berstdruck <i>burst pressure</i>	3		x P _N	
Mediumtemperatur <i>medium temperature</i>	-20 (-4)	100 (212)	°C (°F)	
Umgebungstemperatur <i>ambient temperature</i>	-20 (-4)	85 (185)	°C (°F)	
Lagertemperatur <i>storage temperature</i>	-20 (-4)	85 (185)	°C (°F)	
Werkstoff Gehäuse <i>material housing</i>	Edelstahl			<i>stainless steel</i>
Werkstoff Stirnrad <i>material gear wheel</i>	Einsatzstahl			<i>case hardening steel</i>
Werkstoff Lager <i>material bearing</i>	Edelstahl			<i>stainless steel</i>

<i>material gear</i>				
Dichtungsmaterial / <i>sealing material</i>	FKM (andere auf Anfrage)			FKM (others on request)
Medienverträglichkeit fluid compatibility	Hydrauliköle, Öle auf Mineralölbasis			hydraulic oils, mineral oil based fluids
IP Schutzklasse <i>degree of protection of enclosure</i>		IP 67		IEC 60529:1989+ A1:1999(E)
Versorgungsspannung <i>supply voltage</i>	8	30	VDC	

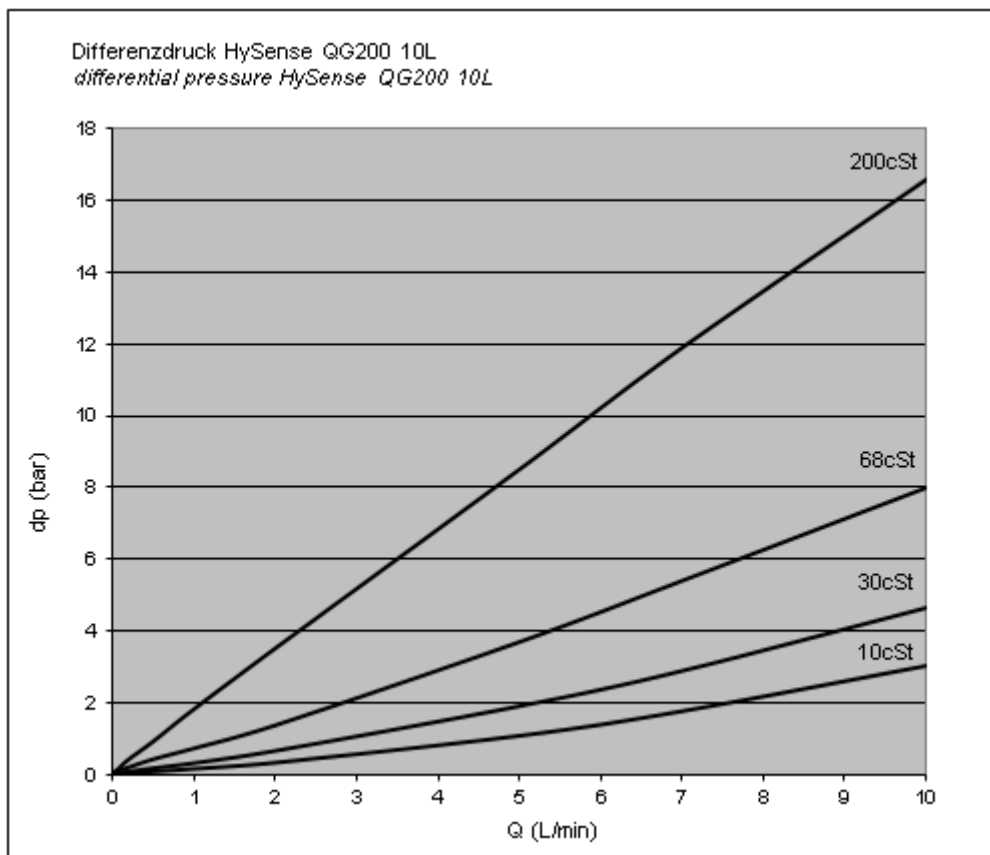
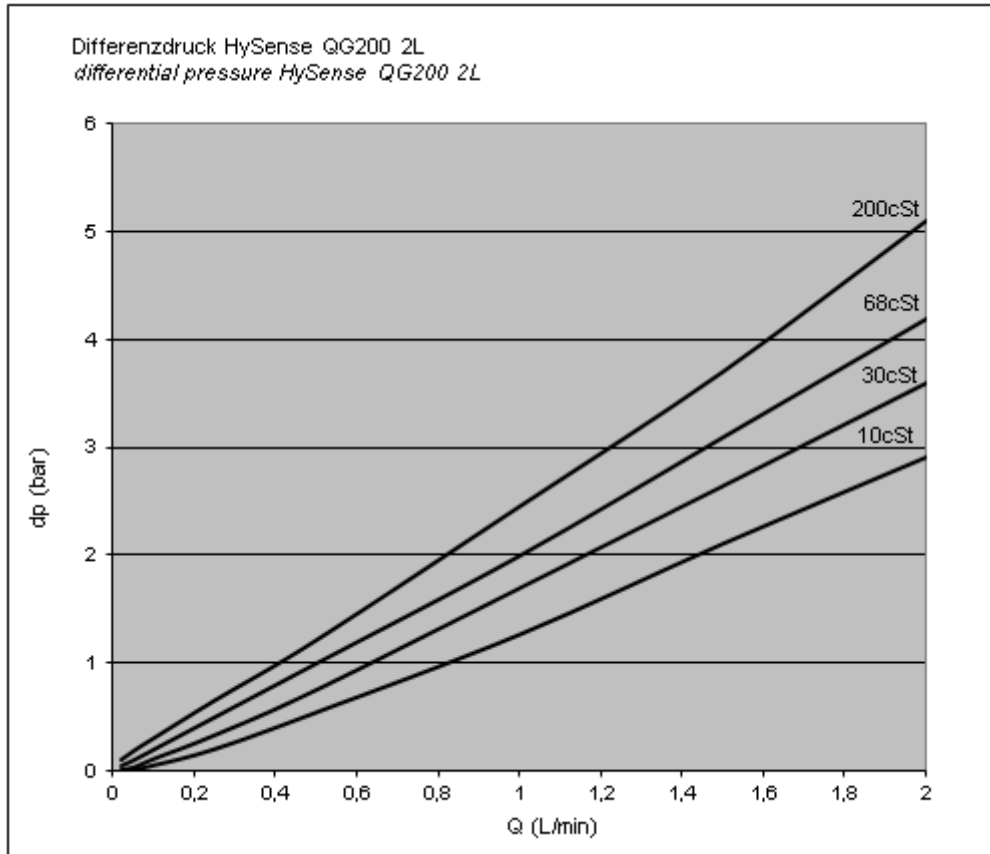

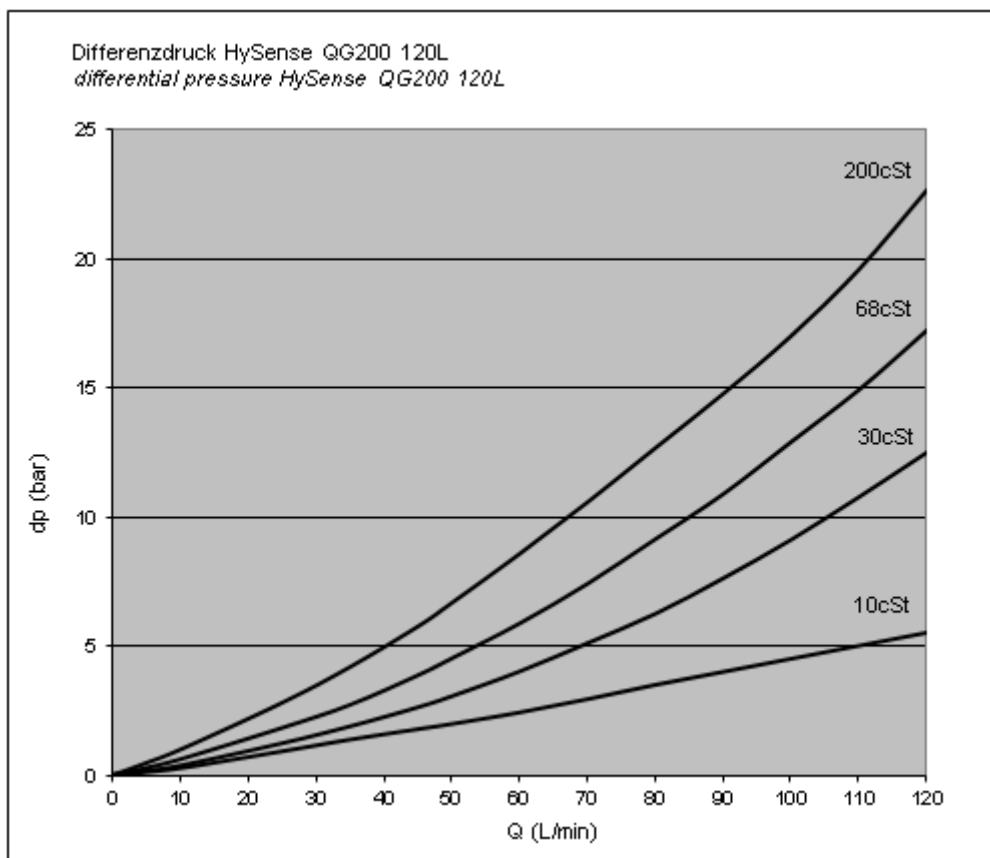
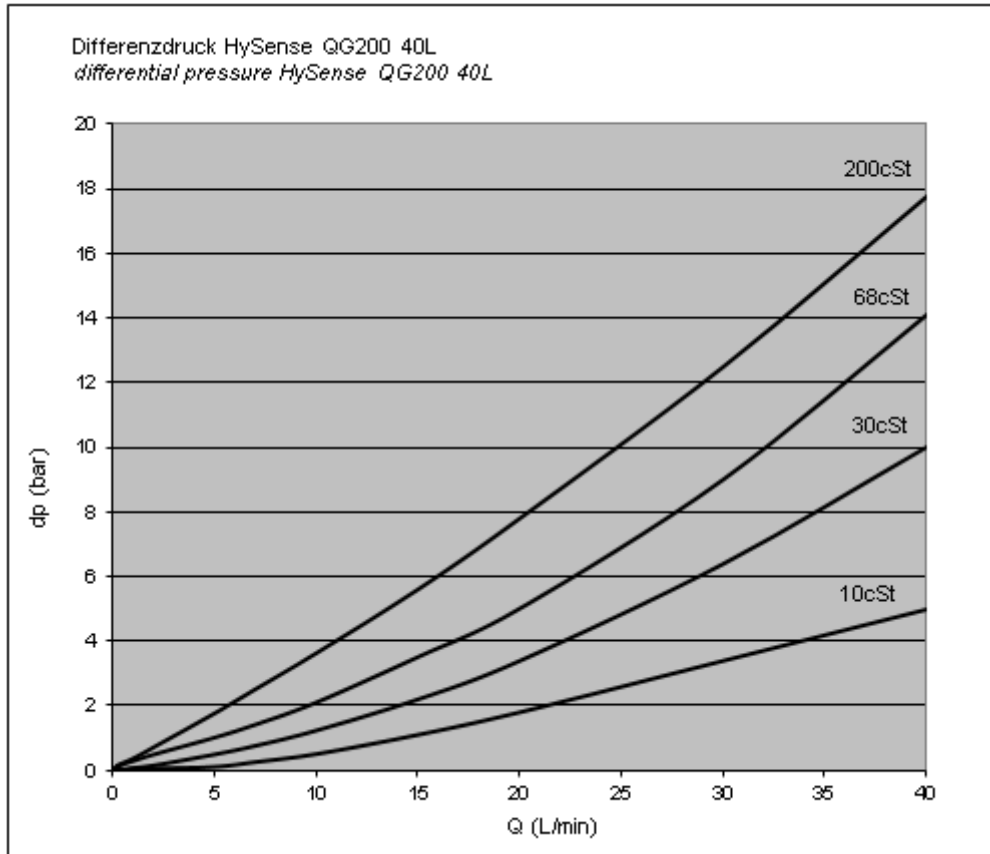

Baugruppenzeichnung
assembly drawing

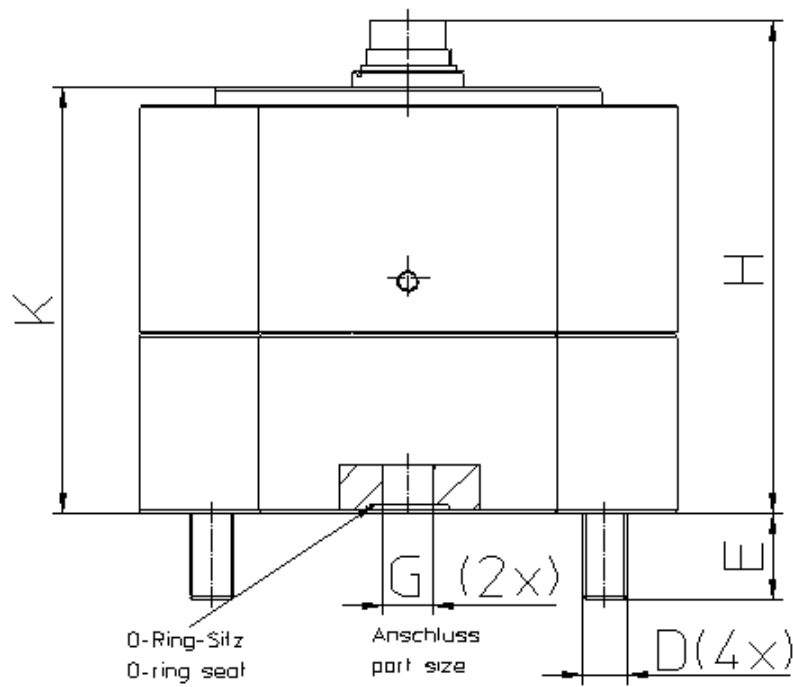
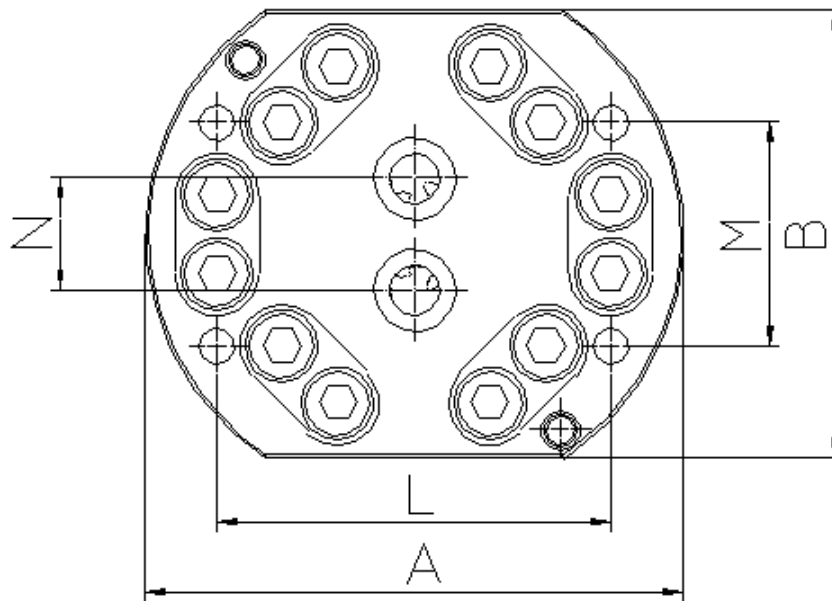

QG200 Bestellnummer order code	kalibrierter Bereich <i>calibrated range</i> [l/min]	Ausgangs- signal <i>Output signal</i>	Fehlergrenze bei Standardviskosität <i>accuracy at standard viscosity</i> 30mm ² /sec [cSt]	geometrisches Zahnvolumen <i>geometric tooth volume</i> [cm ³]	K-Faktor (1) [Imp. / Liter pulses / liter (±2%)]
31UA-01-PF.030	0.02...2	Frequenz <i>frequency</i>	±0.3% vom Messwert <i>of measured value</i>	ca. 0.02	50'000
31UA-03-PF.030	0.1...10			ca. 0.1	10'000
31UA-05-PF.030	0.2...40			ca. 0.4	2'500
31UA-07-PF.030	1...120			ca. 2.0	500
31U0-01-PF.030	0.005...2		±0.5% vom Messwert <i>of measured value</i>	ca. 0.02	50'000
31U0-03-PF.030	0.01...10			ca. 0.1	10'000
31U0-05-PF.030	0.03...40			ca. 0.4	2'500
31U0-07-PF.030	0.2...120			ca. 2.0	500

QG210 Bestellnummer order code	kalibrierter Bereich <i>calibrated range</i> [l/min]	Messbereich <i>measuring range</i> [l/min]	Ausgangssignal <i>Output signal</i>	Fehlergrenze bei Standardviskosität <i>accuracy at standard viscosity</i> 30mm ² /sec [cSt]
31UA-01-PR.030	0.02...2	0...2	4 ... 20mA	±0.3% vom Messwert <i>of measured value</i> plus / <i>additional</i> ±0.15% FS des Signalwandlers bei -25°C...+85°C / 13°F...+185°F
31UA-03-PR.030	0.1...10	0...10		
31UA-05-PR.030	0.2...40	0...40		
31UA-07-PR.030	1...120	0...120		
31U0-01-PR.030	0.005...2	0...2		±0.15% FS of signal converter <i>at -25°C...+85°C / 13°F...+185°F</i>
31U0-03-PF.030	0.01...10	0...10		
31U0-05-PF.030	0.03...40	0...40		
31U0-07-PF.030	0.2...120	0...120		

(1) Der wahre K-Faktor wird auf dem Kalibrierschein ausgewiesen / *The real K-factor will be listed on the calibration certificate*

Bestell- nummer <i>order number</i>	Abmessungen <i>dimensions</i>										
	A [mm]	B [mm]	D [mm]	E [mm]	ØG [mm]	H [mm]	K [mm]	L [mm]	M [mm]	N [mm]	O-Ring [mm]
31Ux-01-Px.xxx	96	80	M6	15	9	89	76	70	40	20	ID 11x2
31Ux-03-Px.xxx	96	80	M6	15	9	89	76	70	40	20	ID 11x2
31Ux-05-Px.xxx	110	90	M8	24	16	90	78	80	38	34	ID 18x2.62
31Ux-07-Px.xxx	142	100	M8	22	16	119	106	84	72	34	ID 18x2.62

Empfohlene Befestigungsschraube - Stahl verzinkt – Güte 10.9 <i>recommended clamping screw - steel zinc chromated – quality 10.9</i>		
31Ux-01-Px.xxx	ISO4762 / DIN 912	M6x80
31Ux-03-Px.xxx	ISO4762 / DIN 912	M6x80
31Ux-05-Px.xxx	ISO4762 / DIN 912	M8x90
31Ux-07-Px.xxx	ISO4762 / DIN 912	M8x120

Typenschlüssel für Zahnradvolumenstromsensor QG2xx
type code for gear flow meter

3	1	U	0	-	07	-	P	F	.	030	
Messgeräte, Sensorik allgemein / instruments, sensors in general	Medienverträglichkeit / medium compatibility	Typ/ type	Ausführung / performance		Durchflussbereich flow range		Bauart type	Signal signal		Kalibrierviskosität calibration viscosity	
										010	10cSt
										030	30cSt (Standard / standard)
										046	46cSt
										xxx	xxxcSt (auf Anfrage / on request)
										F	Frequenz / frequency
										R	4...20mA
										P	Plattenbauweise / subplate design
										01	(0.5%) 0.005...2L/min / (0.3%) 0.02...2L/min
										03	(0.5%) 0.01...10L/min / (0.3%) 0.1...10L/min
05	(0.5%) 0.03...40L/min / (0.3%) 0.2...40L/min										
07	(0.5%) 0.2...120L/min / (0.3%) 1.0...120L/min										
		0	Messgenauigkeit 0.5% / accuracy 0.5%								
		A	Messgenauigkeit 0.3% / accuracy 0.3%								
		U	QG2xx								
	1	Hydrauliköle, Öle auf Mineralölbasis hydraulic oils, mineral oil based fluids									
3											

Typenschild Type plate	<p>HySense QG200 Zahnrad-Volumenstromsensor / Gear Flow Meter</p> <p>Messbereich / Range L/min / US.liq.gal/min</p> <p>Geo. Zahnvolumen / Geometric Gear Volume cm³</p> <p>Best.-Nr. / Part-No. Kalibrierwert / Calibration Value [L/min/kHz] @</p> <p>Werk-Nr. / Serial-No. Viskosität / Viscosity</p> <p>→ @ mm²/s , ← @ mm²/s → @ mm²/s , ← @ mm²/s</p> <p>Pmax.: bar psi MPa</p> <p>MESSEN MIT SYSTEM</p>
---	--

Zubehör und Ersatzteile <i>Accessories and spare parts</i>		
Bestellnummer <i>order number</i>	Beschreibung <i>description</i>	Eigenschaften <i>features</i>
8824-S1-02.50S 8824-S1-05.00S	Messkabel – Standard <i>measuring cable – standard</i> für Sensoren mit/ohne ISDS <i>for sensors with/without ISDS</i>	M16, 6-pol. Stecker – M16, 6-pol. Buchse IP40, max. Zugkraft 160Nm, Länge 2,5m/5,0m <i>M16, 6-pole connector – M16, 6-pole socket</i> <i>IP40, max. traction power 160Nm, length 2.5m/5.0m</i>
8824-S1-02.50H 8824-S1-05.00H	Messkabel – High End <i>measuring cable – high end</i> für Sensoren mit/ohne ISDS <i>for sensors with/without ISDS</i>	M16, 6-pol. Stecker – M16, 6-pol. Buchse IP67, max. Zugkraft 300Nm, Länge 2,5m/5,0m <i>M16, 6-pole connector – M16, 6-pole socket</i> <i>IP67, max. traction power 300Nm, length 2.5m/5.0m</i>
8824-S6-2.50S 8824-S6-5.00S	Messkabel – Standard <i>measuring cable – standard</i> für Sensoren mit/ohne ISDS <i>for sensors with/without ISDS</i>	Offenes Ende – M16, 6-pol. Buchse IP40, max. Zugkraft 160Nm, Länge 2,5m/5,0m <i>Open End – M16 6-pole socket</i> <i>IP40, max. traction power 160Nm, length 2.5m/5.0m</i>
8824-S6-2.50H 8824-S6-5.00H	Messkabel – High End <i>measuring cable – high end</i> für Sensoren mit/ohne ISDS <i>for sensors with/without ISDS</i>	Offenes Ende – M16, 6-pol. Buchse IP67, max. Zugkraft 300Nm, Länge 2,5m/5,0m <i>Open End – M16, 6-pole socket</i> <i>IP67, max. traction power 300Nm, length 2.5m/5.0m</i>

Qualifikationskriterien <i>qualification criteria</i>	HySense Durchflusssensoren, sowie deren Zubehör werden nach einschlägig bekannten Normen getestet und qualifiziert. Die Qualifikation erfolgt an Baumustern des genannten Artikels oder an Teilen, die in Bezug auf die zu untersuchenden Eigenschaften identisch sind.	HySense flow sensors and their equipment are tested and qualified in accordance to relevant engineer standards. <i>The product qualification was carried out on samples of the article or on parts with identical properties with respect to the criteria under investigation.</i>
---	---	---

Druckgeräterichtlinie <i>pressure equipment directive</i>	HySense Durchflusssensoren sind gemäß der Druckgeräterichtlinie 2014/68/EU (Kapitel 4) in Übereinstimmung mit geltender guter deutscher Ingenieurpraxis ausgelegt und hergestellt worden. Damit ist die Produktsicherheit gewährleistet. Diese Produkte sollen die CE-Kennzeichnung unbeschadet der sonstigen Harmonisierungsrechtvorschriften der Union, die für das Anbringen dieser Kennzeichnung gelten, nicht tragen.	HySense flow sensors are designed and produced in reference to the Pressure Equipment Directive 2014/68/EU (chapter 4), in accordance with German engineering practice. Hence, the product safety is guaranteed. <i>The products shall not have a CE label as far as the Pressure Equipment Directive is concerned.</i>
---	--	--

REACH-Regulation (EU) No.1907/2006, Art. 33	<p>Die HYDROTECHNIK GmbH ist als Hersteller von Erzeugnissen, im Sinne der REACH-Verordnung, nachgeschalteter Anwender geringer Mengen und somit nicht registrierungspflichtig. Wir liefern ausschließlich nicht chemische Produkte. Diese beinhalten keine Stoffe, die nach REACH Artikel 7 unter normalen oder vernünftigerweise vorhersehbaren Verwendungsbedingungen zur Freisetzung beabsichtigt sind.</p>	<p><i>HYDROTECHNIK GmbH as a manufacturer of products is, with regard to the REACH regulation, a downstream-user of small quantities. As such it is not obliged to register. We exclusively supply non-chemical products. These do not contain substances which, according to REACH Article 7, are intended for release under normal or reasonably foreseeable conditions of use.</i></p>
Hinweise zu Technischen Daten notes on technical data	<p>Die genannten technischen Daten werden unter Laborbedingungen ermittelt. Hierbei werden die aktuell gültigen Normen zugrunde gelegt, sofern zutreffend. Für nicht durch Normierung definierte Eigenschaften werden in Anlehnung an Normen für verwandte Produkte eigene Testkriterien definiert. Nur insoweit werden Eigenschaften zugesichert. Die Produkte dürfen nur ihrer Bestimmung gemäß verwendet werden. Die Prüfung der Eignung für den vom Auftraggeber vorgesehenen Verwendungszweck bzw. den Einsatz unter Gebrauchsbedingungen, obliegt dem Auftraggeber; hierfür übernimmt die HYDROTECHNIK GmbH keine Gewährleistung. Änderungen an Produkten und Dokumentationen im Sinne des technischen Fortschritts und der stetigen Verbesserung sind vorbehalten und können jederzeit ohne vorherige Mitteilung eintreten. Die dann gültigen Spezifikationen können von den Angaben in dieser Revision des technischen Datenblatts abweichen. Druckfehler sind vorbehalten. Im Zweifelsfall gilt die deutsche Sprachversion.</p>	<p><i>The technical data listed were determined under laboratory conditions. Test criteria were defined in accordance to currently valid norms, as far as available. For properties, which are not defined in any norm for the given product, test criteria are based on norms for similar products. Any liability is limited accordingly. All of the devices and components listed may be used for their intended purpose only. It remains to the customer's responsibility to qualify whether the device is suitable for the customer's intended purpose and the intended conditions of use or not; we do not assume any liability in this respect.</i></p> <p><i>Changes of products and documentation in the sense of technical progress and continuous improvement may occur at any time without prior notification. Hence specifications may than differ from those given in this revision of the technical data sheet. There is no liability for possible misprints. The German language version is valid in any case of doubt.</i></p>