

SERVOVALVES

DIRECT-OPERATED WITH INTEGRATED DIGITAL ELECTRONICS AND FIELDBUS INTERFACE

SERIES D636 AND D637 / SIZES 03 AND 05

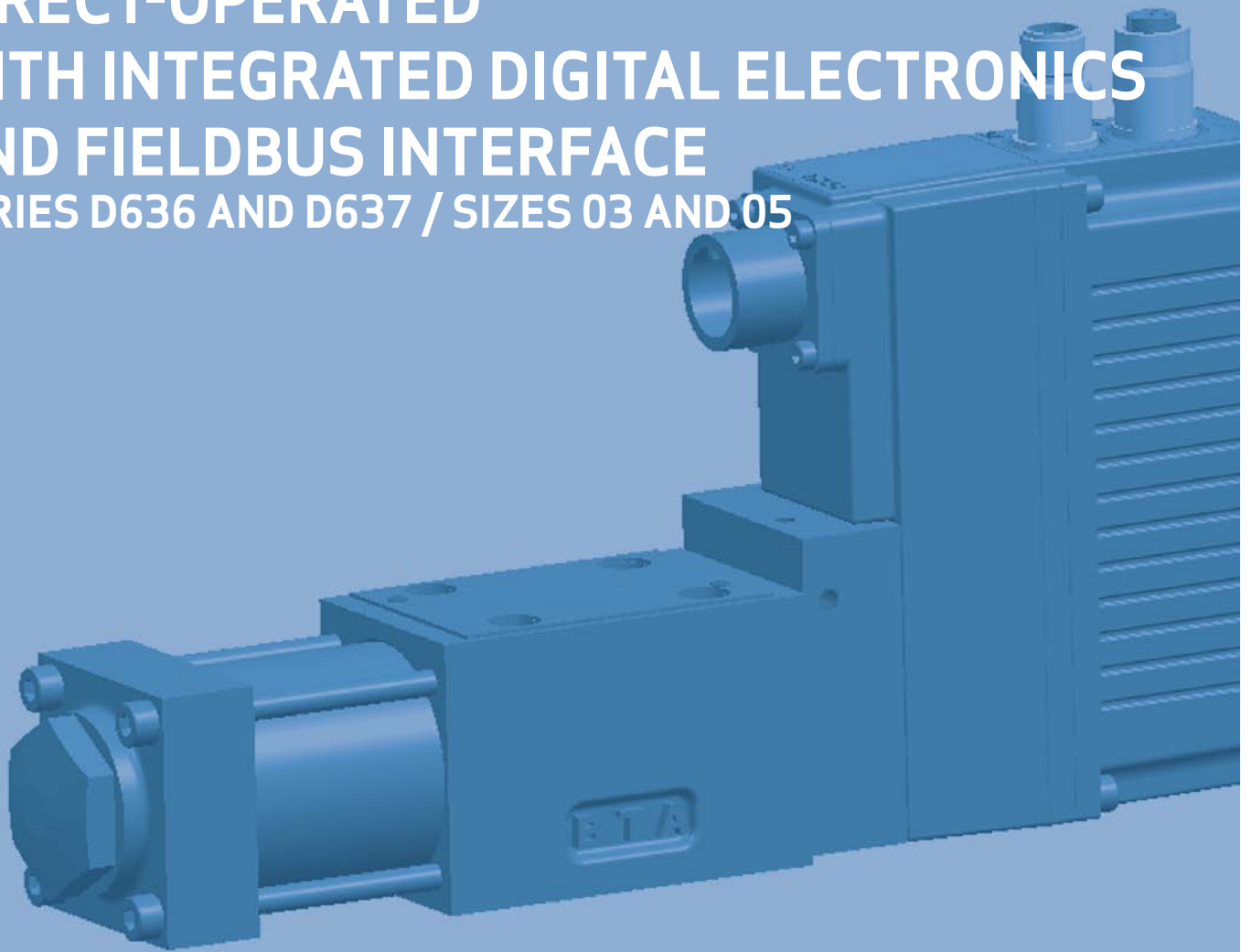

Rev. 2, March 2010

OFFERING FLEXIBLE INTEGRATION AND ADVANCED
MAINTENANCE FEATURES INCLUDING DIAGNOSTICS,
MONITORING OF CHARACTERISTICS AND ABILITY TO
DEFINE DYNAMIC BEHAVIORS

Whenever the highest levels of motion control performance and design flexibility are required, you'll find Moog expertise at work. Through collaboration, creativity and world-class technological solutions, we help you overcome your toughest engineering obstacles. Enhance your product's performance. And help take your thinking further than you ever thought possible.

D636 and D637

Product Overview	3
Features and Benefits	4
Descriptions of Operation	5
Electronics	7
Data Communication	11
Communication Software	12

D636

Technical Data	13
Accessories	20

D637

Technical Data	21
Accessories	27

D636 and D637

Accessories	28
-------------	----

Moog Global Support	29
---------------------	----

Ordering Information	30
----------------------	----

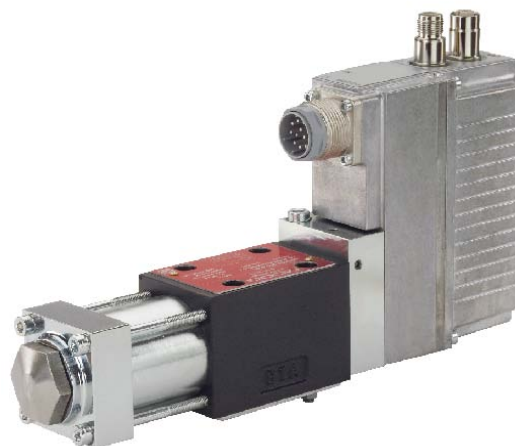

This catalog is for users with technical knowledge. To ensure all necessary characteristics for function and safety of the system, the user has to check the suitability of the products described herein. The products described in this document are subject to change without notice. In case of doubt please contact Moog.

Moog is a registered trademark of Moog Inc. and its subsidiaries. All trademarks as indicated herein are the property of Moog Inc. and its subsidiaries. For the full disclaimer refer to www.moog.com/literature/disclaimers.

For the most current information, visit www.moog.com/industrial or contact your local Moog office.

Excellence in motion control technology

For over 55 years Moog has ranked amongst the leading providers of motion control technology providing high performance products. Moog offers worldclass products using state of the art control techniques that contribute to the performance improvement of machines.

Moog Servovalves and Servo-Proportional Valves

Moog has been producing Servovalves and Servo-Proportional Valves with integrated electronics for over 30 years. Our valves are used in all kinds of machine applications.

Direct drive servovalves

The D636 and D637 Series Valves, sizes 03 and 05 are Direct Drive Servovalves with flow control.

The valves are throttle control valves for 4-(2-, 3-, 2x2-) way applications and are suitable for electrohydraulic control of position, speed, pressure and force even under high dynamic requirements.

Design and application

A permanent magnet linear force motor is used to drive the spool. In contrast to proportional solenoid drives, the linear force motor drives the spool in both working directions from the spring-centered middle position. The strong actuating force of the spool, provides Moog Servovalves with excellent static and dynamic characteristics.

Digital electronics

The digital driver and control electronics are integrated in the valve. The valve electronics contain a microprocessor system which executes all the important functions via the valve software it contains. The digital electronics enables the valve to be controlled across the full range of operation, with significantly reduced influence from temperature and drift.

Fieldbus interface

A built-in fieldbus interface (e.g. CANopen®, Profibus-DP® or EtherCAT®) enables operating parameters to be set, activates the valve and monitors its performance. To reduce wiring, the fieldbus interface is provided with two connectors. Thus, valves may be integrated into the bus without any external T-joints. In addition, up to two analog input commands and up to two analog actual value outputs are available.

Optionally, the valves are available without a fieldbus interface. In this case, the valve is controlled using analog inputs. Valve parameters are set using the integrated M8 service connector.

Axis control

In addition, axis control functionality such as position control, velocity control and force control can be added to the valves. The control mode can be switched over from one to the other by defined events.

Our application engineers can assist you with any additional information you may require.

Benefits of Direct Drive Servovalves with integrated digital electronics

- Fieldbus data transfer: Electrically isolated fieldbus interface
- Diagnostic capabilities: Integrated monitoring of important ambient and internal data. Valve parameters can be changed on site or remotely
- Flexibility: Since parameters may be downloaded using the fieldbus or a high level PLC program, valve parameters may be tuned during a machine cycle while the machine is operating
- Direct drive with permanent magnet linear force motor that provides high actuating force, works in 2 directions
- Pilot oil not required
- Pressure-independent dynamic response
- Low hysteresis and high response characteristics
- Low power demand at and in the proximity of hydraulic zero. Hydraulic zero is the spool position at which the pressures of a symmetrical spool are equal in both blocked control ports
- If the electrical supply fails, a cable breaks or emergency stop is activated, the spool returns to the predefined spring-centered position without passing a fully open control port position (fail-safe) increasing safety

D636 Series single-stage drive servovalve

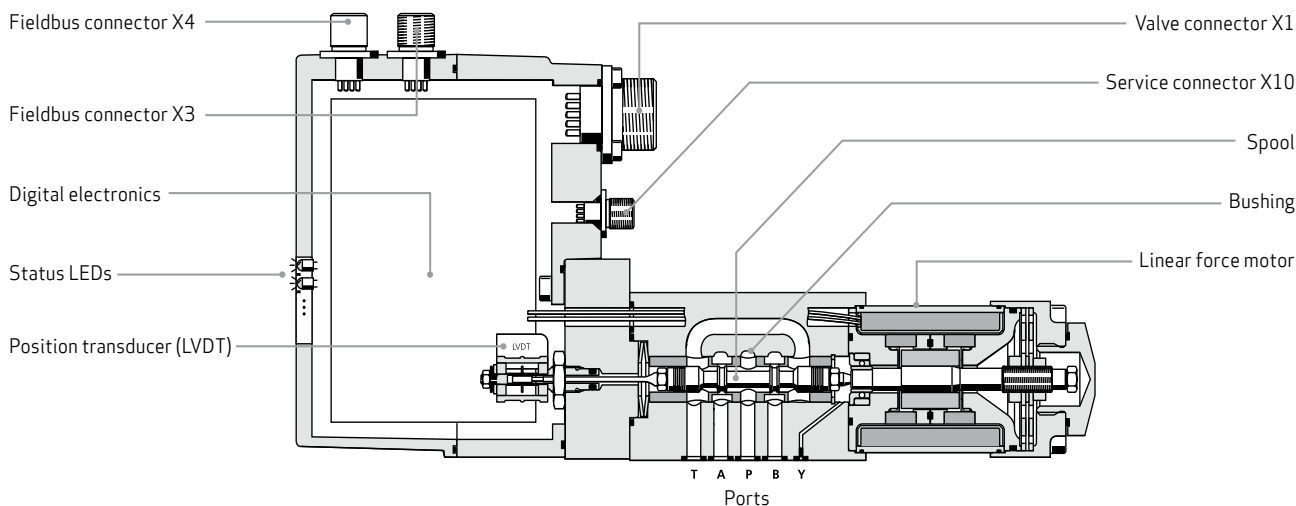

Description of operation of the permanent magnet linear force motor

The linear force motor is a permanent magnet excited differential motor.

Some of the magnetic force is already provided by the permanent magnets. The linear force motor's power demand is thus significantly lower than the comparable proportional solenoid.

The linear force motor drives the servovalve's spool. The spool starting position is determined in the de-energized state by the centering springs. The linear force motor enables the spool to be deflected from the starting position in both directions. The actuating force of the linear force motor is proportional to the coil current.

The high forces of the linear force motor and centering springs effect precise spool movement even against flow and frictional forces.

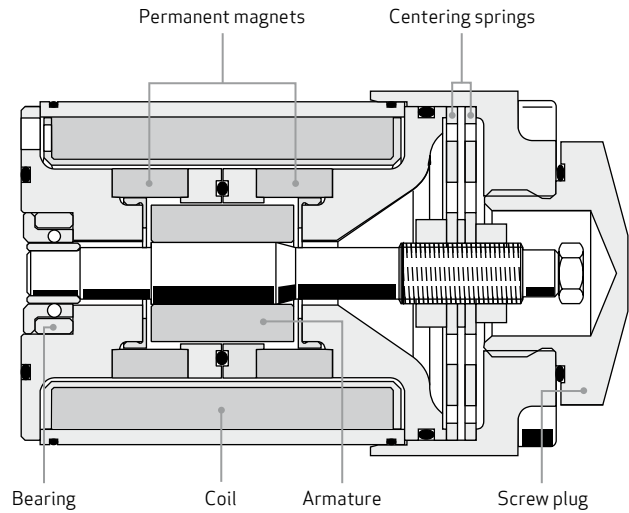

4-way and 3-way operation

In 4-way operation the servovalves can be used to control the flow in ports A and B (used as throttle valves). Port A or B must be closed in order to obtain 3-way operation.

Leakage port Y must be used if the pressure in tank port T exceeds a value of 50 bar (725 psi). The valves are available with zero lap, less than 3 % or 10 % positive overlap.

4-way operation with fail-safe function ¹⁾

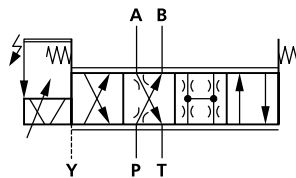

3-way operation with fail-safe function ¹⁾

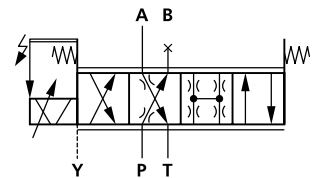

2-way and 2x2-way operation

In 2-way and 2x2-way operation the control valves can be used to control the flow in one direction (used as throttle valves).

In 2x2-way operation the valve can be used in 2-way applications for higher flows. It is necessary to connect ports P with B and A with T externally for this purpose.

2-way operation ¹⁾

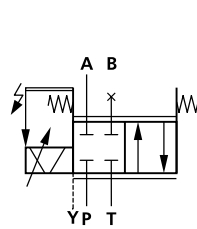

2x2-way operation ¹⁾

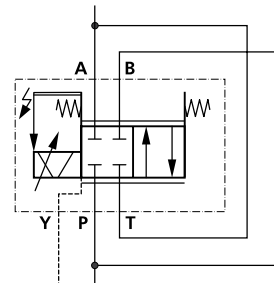

¹⁾ Hydraulic symbol D636

Servovalve operational mode

The D636 and D637 Series Valves are valves with flow control. In this operating mode the position of the spool is controlled. The command signal corresponds to a particular spool position.

The command signal (spool position command) is transmitted to the valve electronics. The actual spool position is measured with a position transducer (LVDT) and transmitted to the valve electronics. The electronics compares the actual spool position and command signal and generates a signal to drive the linear force motor, which moves the spool into the corresponding position.

The position command can be modified by parameters in the valve software (e.g. linearization, ramping, dead band, sectionally defined amplification, etc.).

Flow calculation

The actual valve flow is dependent on the spool and the pressure drop Δp across the spool lands.

At 100 % command signal the valve flow at rated pressure drop $\Delta p_N = 35 \text{ bar (500 psi)}$ per metering land is the rated flow Q_N . For other than rated pressure drop, the valve flow changes at a constant signal according to the following formula.

$$Q = Q_N \cdot \sqrt{\frac{\Delta p}{\Delta p_N}}$$

Q [l/min (gpm)] = actual flow
 Q_N [l/min (gpm)] = rated flow
 Δp [bar (psi)] = actual valve pressure drop
 Δp_N [bar (psi)] = rated valve pressure drop

The actual flow Q must not exceed a mean flow velocity of 30 m/s (96.54 ft/s) at ports P, A, B and T.

FLOW DIAGRAM

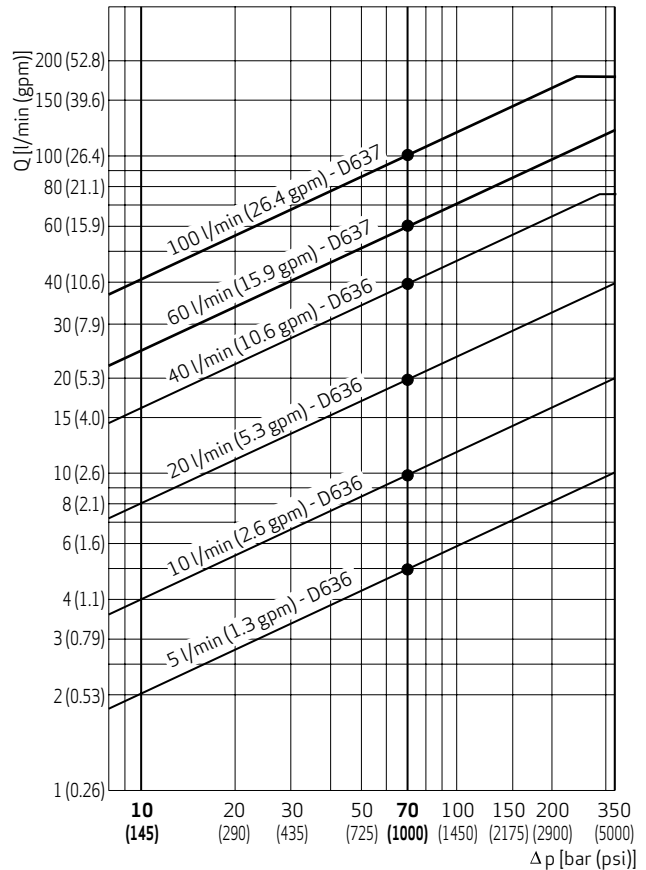

Signal and pin assignment for valves with analog interfaces 6-pole + PE (11-pole + PE)

Command signal ± 10 V, floating

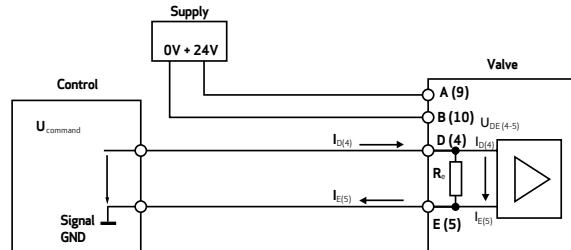

Command signal ± 10 mA, floating

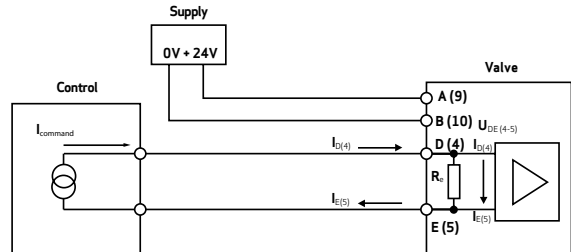

Command signal 4 to 20 mA, floating

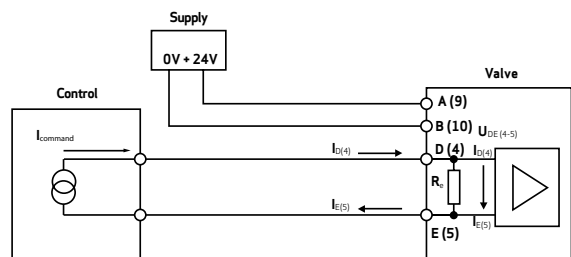

Actual value $I_{outF(6)}$ (spool position)

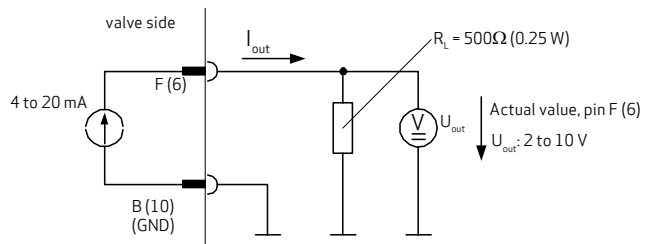

The letters without parentheses denote the pins on the 6-pole + PE connector, the numbers in parentheses denote the pins on the 11-pole + PE connector. For further information, see also Moog Technical Notes TN353 and TN494.

Order code	Command signal $\pm 100\%$ spool stroke	Actual value $\pm 100\%$ spool stroke	Command signal polarity		Actual value polarity		Hydraulic
			6-pole + PE	11-pole + PE	6-pole + PE	11-pole + PE	
E	4 to 20 mA	4 to 20 mA	$I_D = -I_E = 20$ mA	$I_4 = -I_5 = 20$ mA	$I_F = -I_B = 20$ mA	$I_6 = -I_2 = 20$ mA	P \rightarrow A and B \rightarrow T
M	± 10 V	4 to 20 mA	$U_D - U_E = 10$ V	$U_4 - U_5 = 10$ V	$I_F = -I_B = 20$ mA	$I_6 = -I_2 = 20$ mA	P \rightarrow A and B \rightarrow T
X	± 10 mA	4 to 20 mA	$I_D = -I_E = 10$ mA	$I_4 = -I_5 = 10$ mA	$I_F = -I_B = 20$ mA	$I_6 = -I_2 = 20$ mA	P \rightarrow A and B \rightarrow T

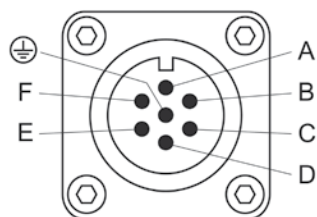

Pin assignment for valves with 6-pole + PE connector (X1)

Pin assignment as per EN 175201-804, mating connector (type R or S, metal) with preleading earth pin (⊕).

Pin	Pin assignment	Voltage, floating ±10 V	Current, floating ±10 mA, 4 to 20 mA ¹⁾
A	Supply voltage	24 V DC (18 to 32 V DC) referred to GND (polarized against GND)	
B	GND	Supply ground / signal ground	
C	Enable input	> 8.5 to 32 V DC referred to GND: valve ready for operation (enabled) < 6.5 V DC referred to GND: valve not ready for operation (disabled) The input resistance is 10 kΩ.	
D	Command signal, difference amplifier input ²⁾	$U_{in} = U_{D-E}$ $R_{in} = 20 \text{ k}\Omega$	$I_{in} = I_D = -I_E$ $R_{in} = 200 \Omega$ $I_{max} = \pm 25 \text{ mA}$
E			
F	Actual value output	I_{out} : 4 to 20 mA referred to GND (I_{out} is proportional to the spool position. 12 mA corresponds to the valve center position.)	
⊕	Protective earth (PE)	Connected with valve body	

¹⁾ Command signals $I_{in} < 3 \text{ mA}$ (e.g. due to an open circuit) indicate a fault in the 4 to 20 mA signal range. The valve response to this fault can be configured and activated by the customer.

²⁾ The potential difference (referred to GND) must be between -15 V and +32 V.

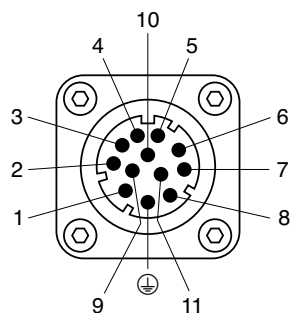

Pin assignment for valves with 11-pole + PE connector (X1)

Pin assignment as per EN 175201-804, mating connector (metal) with preleading protective earth pin (⊕).

Pin	Pin assignment	Voltage, floating ±10 V	Current, floating ±10 mA, 4 to 20 mA ¹⁾
1	Not assigned		
2			
3	Enable input	> 8.5 to 32 V DC referred to GND: valve ready for operation (enabled) < 6.5 V DC referred to GND: valve not ready for operation (disabled) The input resistance is 10 kΩ.	
4	Command input, difference amplifier input ²⁾	$U_{in} = U_{4-5}$ $R_{in} = 20 \text{ k}\Omega$	$I_{in} = I_4 = -I_5$ $R_{in} = 200 \Omega$ $I_{max} = \pm 25 \text{ mA}$
5			
6	Actual value output	$I_{out} = 4 \text{ to } 20 \text{ mA}$ referred to GND. $R_L = 500 \Omega$ (I_{out} is proportional to the spool position. 12 mA corresponds to the valve center position.)	
7	Not assigned		
8	Digital output, valve status	ON: enable & supply OK. Valve is ready for operation. Nominal load voltage: 24 VDC, Load type: ohmic, inductive, lamp load Output current maximum 1.5 A (short-circuit-proof) ³⁾	
9	Supply voltage	24 V DC (18 to 32 V DC) referred to GND (polarized against GND)	
10	GND	Supply ground / signal ground	
11	Digital output	OFF: indicates fault ⁴⁾ Nominal load voltage: 24 VDC, Load type: ohmic, inductive, lamp load Output current maximum 1.5 A (short-circuit-proof) ³⁾	
⊕	Protective earth (PE)	Connected with valve body	

¹⁾ Command signals $I_{in} < 3 \text{ mA}$ (e.g. due to an open circuit) indicate a fault in the 4 to 20 mA signal range. The valve response to this fault can be configured and activated by the customer.

²⁾ The potential difference (referred to GND) must be between -15 V and +32 V.

³⁾ The sum total of the currents drawn at the outputs pin 8 & pin 11 (measured to GND) must be added to the valve supply current. The valve fuse must be configured for the total current.

⁴⁾ Output can be programmed at the factory, "OFF" signal indicates fault (e.g. command signal/actual value deviation).

CANopen® connectors (X3, X4)

- Coding A
- Thread M12x1
- 5-pole

Pin	Signal X3, X4	Description
1	CAN_SHLD	Shield
2	CAN_V+	Not connected in the valve
3	CAN_GND	Ground
4	CAN_H	Transceiver H
5	CAN_L	Transceiver L

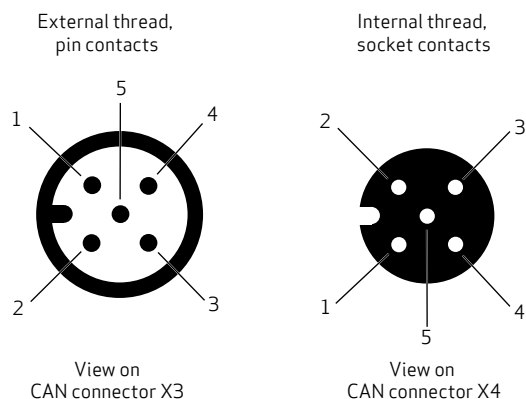

Profibus-DP® connectors (X3, X4)

- Coding B
- Thread M12x1
- 5-pole

Pin	Signal X3, X4	Description
1	Profi V+	Supply voltage 5 V of terminal resistors
2	Profi A	Receive/transmit data -
3	Profi GND	Ground
4	Profi B	Receive/transmit data +
5	Shield	Shield

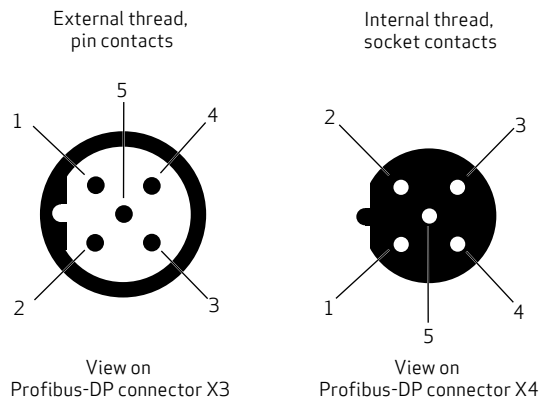

EtherCAT® IN & OUT connectors (X3, X4)

- Coding D
- Thread M12x1
- 4-pole

Pin	Signal X4 IN	Signal X3 OUT	Description
1	TX + IN	TX + OUT	Transmit
2	RX + IN	RX + OUT	Receive
3	TX - IN	TX - OUT	Transmit
4	RX - IN	RX - OUT	Receive

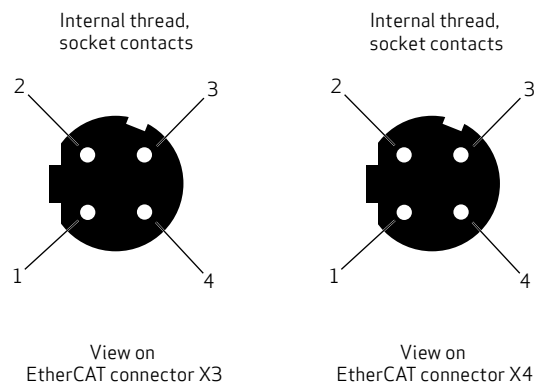

General Information

Modern automation technology is characterized by an increasing decentralization of processing functions via serial data communication systems. The use of serial bus systems in place of conventional connection technologies guarantees greater system flexibility with regard to alterations and expansions. It additionally opens up considerable potential for saving project planning and installation costs in many areas of industrial automation. Further possibilities of parameterization, better diagnostic options and a reduction of the variety of variants are advantages which have only been made possible by the use of fieldbuses.

VDMA profile

In one working group within the VDMA (German Machinery and Plant Manufacturers' Association), a profile was created in collaboration with numerous well-known hydraulic system manufacturers. This profile describes communication between hydraulic components via a fieldbus. It defines uniform functions and parameters in a standardized exchange format.

CANopen®

In accordance with EN 50325-4. The CAN bus was originally developed for use in automobiles, but has also been used for years in various fields of machine construction. The CAN bus is designed above all for transmission reliability and speed.

The CAN bus has the following features:

- Multi-master system:
Each node can transmit and receive
- Topology:
Line structure with short stub lines
- Network extension and band widths:
25 m (80.4 ft) at 1 Mbit/s to 5000 m (16090 ft) at 25 kbit/s
- Addressing type:
Message-orientated via identifiers. Priority assignment of the message via identifier
- Security:
Hamming distance = 6, i.e. up to 6 individual errors per message are detected
- Bus physics:
ISO 11989
- Maximum number of nodes: 127

Profibus-DP®

In accordance with EN 61158. Profibus-DP® was developed for the process and manufacturing industries and is thereby supported by numerous control system manufacturers.

The Profibus-DP® has the following features:

- Multi-master system:
Several masters share access time and initiate communication. Slaves react only on request
- Topology:
Linear structure with short stub lines
- Network expansion and transmission rates:
100 m (321.8) at 12 Mbit/s to 1200 m (3861.6 ft) at 9.6 kbit/s per segment. Use of repeaters possible
- Addressing type:
Address-orientated. Priority/cycle time assignment of messages via master configuration
- Bus physics:
RS-485 in accordance with EIA-485
- Maximum number of nodes:
126

EtherCAT®

In accordance with IEC/PAS 62407. EtherCAT® has been developed as an industry bus based on Ethernet to meet increasing demands regarding cycle time. The EtherCAT® bus is designed for high data transmission rates and fast cycle times.

The EtherCAT® bus has the following features:

- Single-master system:
Master initiates communication. Slaves react only on request
- Topology:
Line, star, tree and ring structure based on the daisy chain principle
- Network expansion and transmission rates:
100 m (321.8 ft) between two nodes, 100 Mbit/s
- Addressing type:
Address-orientated, one datagram for all nodes
- Bus physics:
Fast Ethernet 100 Base Tx
- Maximum number of nodes:
65535

General information

The Windows®-based “Moog Valve Configuration Software” developed by Moog enables fast and convenient commissioning, diagnostics and configuration of the valve. Data may be uploaded from the PC to the valve and; current settings may be downloaded from the valve to the PC and displayed. The valve can be controlled by means of graphic control elements. Status information, command signals, actual values and characteristic curves are represented in graphical form. System parameters can be recorded and visualized by means of an integrated oscilloscope / data logger.

Configuration software

System requirements:

The configuration software can be installed on a PC with the following minimal requirements:

- IBM PC-compatible with 133 MHz
- Windows® 95/98/ME, Windows® NT/2000/XP/Vista
- 64 MB RAM
- 40 MB free hard disk space
- Monitor 640x480 pixel resolution
- Keyboard, mouse

Recommended requirements:

- IBM PC-compatible with 300 MHz
- Windows® NT/2000/XP/Vista

The following equipment is also required to be able to use the software (see section “D636 and D637 Accessories”):

- Free USB port
- USB starting-up module
- Configuration/commissioning cable
- Valve connection cable (6-pole + PE or 11-pole + PE)
- Adapter for M8 service connector (not necessary for valves with CANopen® interface)
- Power pack 24 V DC / 2 A

Note

Configuration/starting-up with the “Moog Valve Configuration Software” can be performed on valves with a CANopen® interface via the fieldbus connectors, otherwise (valves with Profibus-DP® or EtherCAT® interface or purely analog activation) via the integrated M8 service connector. It is not permitted to operate the “Moog Valve Configuration Software” on a fieldbus while the bus is communicating.

The software is available from Moog upon request.

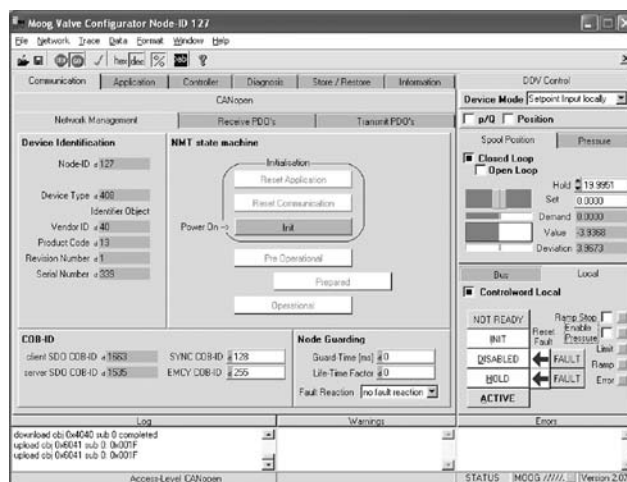

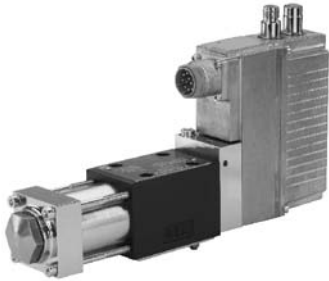

D636 Series Servovalve with rated flow up to 40 l/min (10.6 gpm)

Technical data	Description
Design	Single-stage spool valve with bushing
Actuation	Directly with permanent magnet linear force motor
Valve configuration	2-way, 3-way, 4-way and 2x2-way operation
Mounting pattern	ISO 4401-03-03-0-05 (with or without leakage port Y)
Diameter of ports	7.9 mm (0.31 in)
Installation position	As desired
Mass	2.5 kg (5.5 lb)
Storage temperature range	-40 °C to +80 °C (-40 °F to +176 °F)
Ambient temperature range	-20 °C to +60 °C (-4 °F to +140 °F)
Vibration resistance	30 g, 3 axes, 10 Hz to 2 kHz (as per EN 60068-2-6)
Shock resistance	50 g, 6 directions, half-sine 3 ms (as per EN 60068-2-27)

Hydraulic data**(measured at 140 bar (2,000 psi), fluid viscosity 32 mm²/s (cSt) and fluid temperature 40 °C (104 °F))**

Technical data	Description
Maximum operating pressure range, port P, A, B	350 bar (5,000 psi)
Maximum operating pressure range, port T without Y	50 bar (725 psi)
Maximum operating pressure range, port T with Y	350 bar (5,000 psi)
Maximum operating pressure range, port Y	Depressurized to tank
Maximum flow	75 l/min (19.8 gpm)
Rated flow (model-dependent) at Δp rated 35 bar (500 psi)/land	5 / 10 / 20 / 40 l/min (1.3 / 2.6 / 5.3 / 10.6 gpm)
Leakage flow at zero lap (model-dependent)	0.15 / 0.3 / 0.6 / 1.2 l/min (0.04 / 0.08 / 0.16 / 0.32 gpm)
Hydraulic fluid	Hydraulic fluid as per DIN 51524 Parts 1 to 3 and ISO 11158 Other fluids upon request
Seal material	HNBR, FKM, others upon request
Temperature range of hydraulic fluid	-20 °C to +80 °C (-4 °F to +176 °F)
Viscosity range, recommended	15 mm ² /s (cSt) to 100 mm ² /s (cSt)
Viscosity range, maximum permissible	5 mm ² /s (cSt) to 400 mm ² /s (cSt)
Recommended cleanliness class for functional safety as per ISO 4406 ¹⁾	< 18 / 15 / 12
Recommended cleanliness class for endurance (wear) as per ISO 4406 ¹⁾	< 17 / 14 / 11

Typical static and dynamic data

Technical data	Description
Step response time for 0 to 100 % stroke (typical)	8 ms
Hysteresis	< 0.05 % (typical) 0.10 % (maximum)
Null shift at $\Delta T = 55$ K	< 1.5 %
Manufacturing tolerance with respect to Q_{rated}	< 3 %

¹⁾ The cleanliness of the hydraulic fluid has a great effect on functional safety (reliable spool positioning, high resolution) and wear of the spool lands (pressure gain, leakage losses).

Electrical data	Description
Duty factor	100 %
Degree of protection as per EN 60529	IP 65 with mounted mating connectors or with mounted dust protection caps with sealing function
Supply voltage	18 V DC to 32 V DC (see Electronics section)
Maximum current consumption	1.7 A
Fuse protection, external, per valve	2 A (slow-blowing)
Power consumption of motor in neutral position	9.6 W (0.4 A at 24 V DC)
Maximum power consumption	28.8 W (1.2 A at 24 V DC)
EM compatibility	Emitted interference as per EN 61000-6-4:2005, (CANopen® and Profibus-DP®); Emitted interference as per EN 61000-6-3:2005, (EtherCAT®); Immunity to interference as per EN 61000-6-2:2005, (evaluation criterion A);
Connector type	See Electronics section
Triggering electronics	Integrated in the valve, see Electronics section

Characteristic curves (typical)¹⁾

STEP RESPONSE

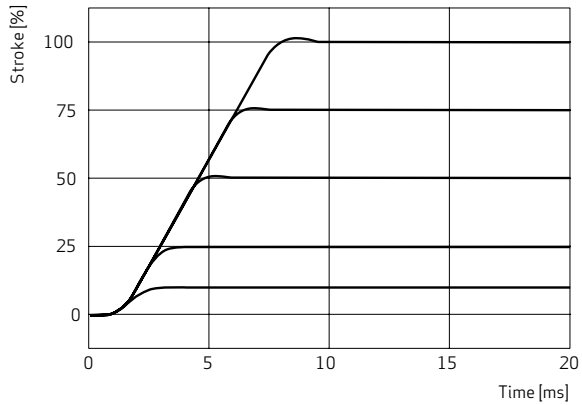

FREQUENCY RESPONSE

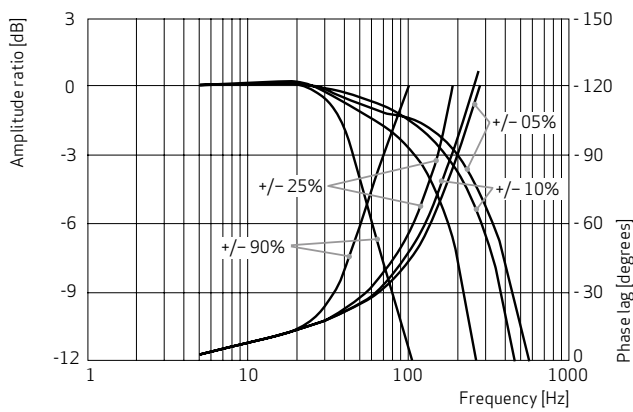

PRESSURE SIGNAL CURVE (valve with zero lap)

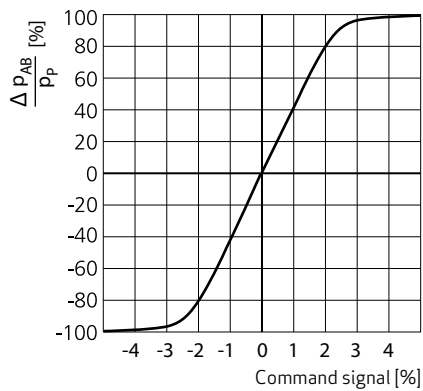

VALVE FLOW SIGNAL CURVE (valve with zero lap)

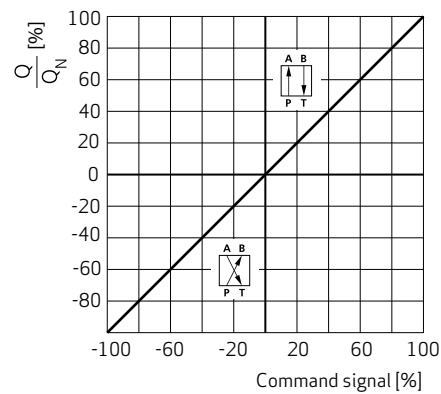

¹⁾ At operating pressure $p_p = 140$ bar (2,000 psi), fluid viscosity $\nu = 32$ mm²/s (cSt) and a fluid temperature of 40° C (104 °F)

INSTALLATION DRAWINGS FOR VALVES WITH CANOPEN FIELDBUS CONNECTOR

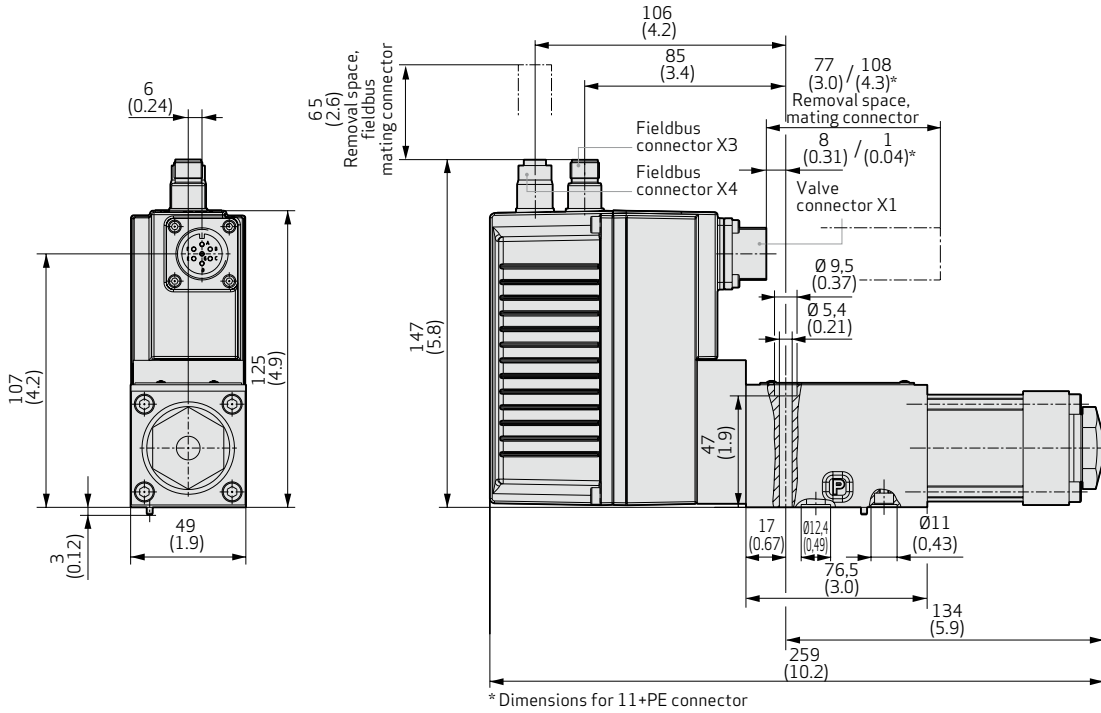

INSTALLATION DRAWINGS FOR VALVES WITH PROFIBUS-DP OR ETHERCAT FIELDBUS CONNECTOR

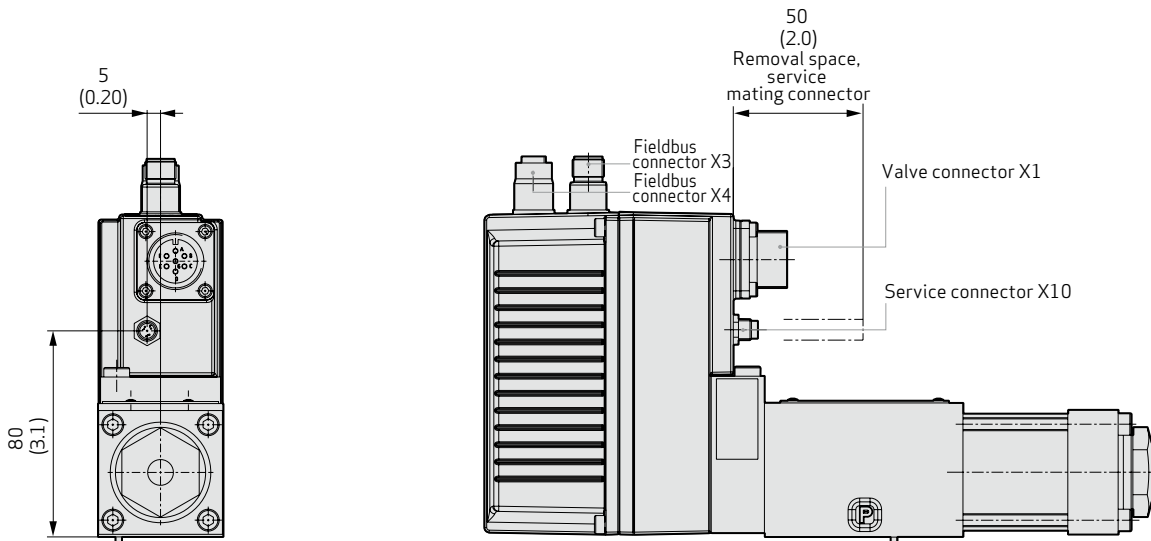

INSTALLATION DRAWINGS FOR VALVES WITH ANALOG ACTIVATION

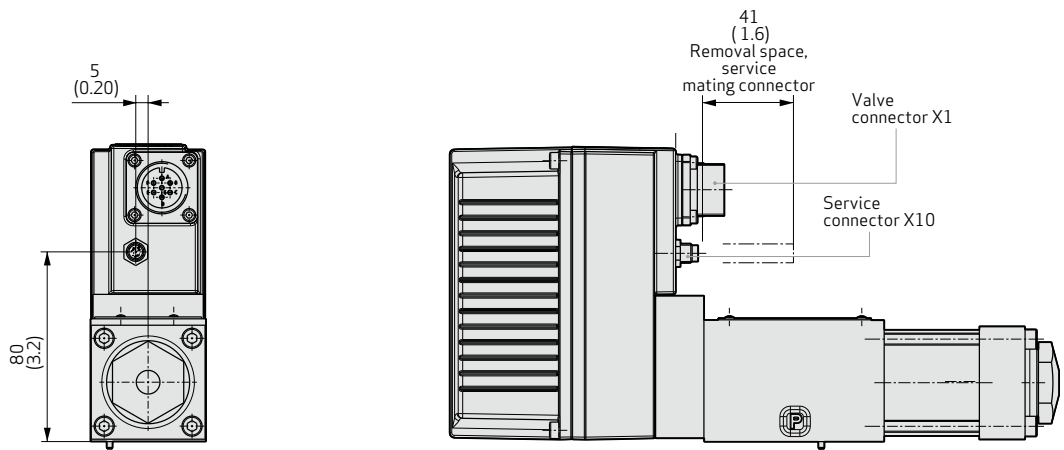

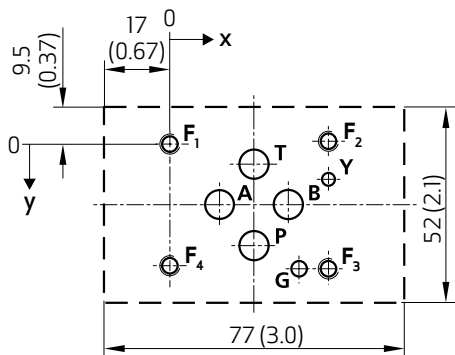

Mounting pattern of mounting surface

(ISO 4401-03-03-0-05)
 Flatness of mounting surface < 0.01 mm (0.0004 in)
 over 100 mm (3.94 in), average surface finish
 $R_a = 0.8 \mu\text{m}$ (0.0000314 in)

	P	A	B	T	X ¹⁾	Y	F ₁	F ₂	F ₃	F ₄	G ²⁾
	Ø 7.5 (0.30)	Ø 7.5 (0.30)	Ø 7.5 (0.30)	Ø 7.5 (0.30)		Ø 3.3 (0.13)	M5	M5	M5	M5	Ø 4 (0.16)
X	21.5 (0.85)	12.7 (0.50)	30.2 (1.19)	21.5 (0.85)		40.5 (1.59)	0	40.5 (1.59)	40.5 (1.59)	0	33 (1.30)
Y	25.9 (1.02)	15.5 (0.61)	15.5 (0.61)	5.1 (0.20)		9 (0.35)	0	-0.75 (-0.03)	31.75 (1.25)	31 (1.22)	31.75 (1.25)

¹⁾ Do not drill port X, as not sealed in the valve.

²⁾ Minimum 4 mm (0.157 in) depth

D636 - Spare parts

Part designation	Description	Part number
Shipping plate		B46035-001
O-rings for ports P, T, A, B (4 rings per valve required)	ID 9.25 x Ø 1.8: HNBR 90 Shore (ID 0.36 x Ø 0.07)	B97009-013
O-ring for ports P, T, A, B (4 rings per valve required)	ID 9.25 x Ø 1.8: FKM 90 Shore (ID 0.36 x Ø 0.07)	-42082-013
O-ring for port Y	ID 7.65 Ø 1.8: HNBR 90 Shore (ID 0.3 x Ø 0.07)	B97009-012
O-ring for port Y	ID 7.65 Ø 1.8: FKM 90 Shore (ID 0.3 x Ø 0.07)	-42082-012

D636 - Accessories

Part designation	Description	Part number
Service sealing kit with O-rings for ports P, T, A, B, Y	HNBR 90 Shore	B97215-H630F63
Service sealing kit with O-rings for ports P, T, A, B, Y	FKM 90 Shore	B97215-V630F63
Installation screws of servovalve (4 screws per valve required)	M5x55, ISO 4762-10.9 tightening torque: 6.8 Nm (60 in-lbs)	A03665-050-055
Flushing plate for P, A, B, T, X, Y		B46634-002

D636 - Documents

Designation	Description	Part number
Manual D636 Series Servovalves	Operating instructions	CA45707-001 ¹⁾

¹⁾ Download the document at www.moog.com/industrial/literature

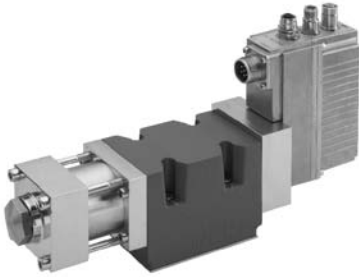

D637 Series Servovalve with rated flow up to 100 l/min (26.4 gpm)

Technical data	Description
Design	Single-stage spool valve with bushing
Actuation	Directly with permanent magnet linear force motor
Valve configuration	2-way, 3-way, 4-way and 2x2-way operation
Mounting pattern	ISO 4401-05-05-0-05 (with or without leakage port Y)
Diameter of ports	11.5 mm (0.45 in)
Installation position	As desired
Mass	7.9 kg (17.4 lb)
Storage temperature range	-40 °C to +80 °C (-40 °F to +176 °F)
Ambient temperature range	-20 °C to +60 °C (-4 °F to +140 °F)
Vibration resistance	30 g, 3 axes, 10 Hz to 2 kHz (as per EN 60068-2-6)
Shock resistance	50 g, 6 directions, half-sine 3 ms (as per EN 60068-2-27)

Hydraulic data**(measured at 140 bar (2,000 psi), fluid viscosity 32 mm²/s (cSt) and fluid temperature 40 °C (104 °F))**

Technical data	Description
Maximum operating pressure range, port P, A, B	350 bar (5,000 psi)
Maximum operating pressure range, port T, T ₁ without Y	50 bar (725 psi)
Maximum operating pressure range, port T, T ₁ with Y	210 bar (3,000 psi)
Maximum operating pressure range, port Y	Depressurized to tank
Maximum flow	180 l/min (47.6 gpm)
Rated flow (model-dependent) at Δp rated 35 bar (500 psi)/land	60 / 100 l/min (15.9 / 26.4 gpm)
Leakage flow at zero lap (model-dependent)	1.2 / 2 l/min (0.32 / 0.53 gpm)
Hydraulic fluid	Hydraulic fluid as per DIN 51524 Parts 1 to 3 and ISO 11158 Other fluids upon request
Seal material	NBR, FKM, others upon request
Temperature range of hydraulic fluid	-20 °C to +80 °C (-4 °F to +176 °F)
Viscosity range, recommended	15 mm ² /s(cSt) to 100 mm ² /s (cSt)
Viscosity range, maximum permissible	5 mm ² /s (cSt) to 400 mm ² /s (cSt)
Recommended cleanliness class for functional safety as per ISO 4406 ¹⁾	< 18 / 15 / 12
Recommended cleanliness class for endurance (wear) as per ISO 4406 ¹⁾	< 17 / 14 / 11

Typical static and dynamic data

Technical data	Description
Step response time for 0 to 100 % stroke (typical)	14 ms
Hysteresis	< 0.05 % (typical) 0.10 % (maximum)
Null shift at $\Delta T = 55 K$	< 1.5 %
Manufacturing tolerance with respect to Q _{rated}	< 3 %

¹⁾ The cleanliness of the hydraulic fluid has a great effect on functional safety (reliable spool positioning, high resolution) and wear of the spool lands (pressure gain, leakage losses).

Electrical data	Description
Duty factor	100 %
Degree of protection as per EN 60529	IP 65 with mounted mating connectors or with mounted dust protection caps with sealing function
Supply voltage	18 V DC to 32 V DC (see Electronics section)
Maximum current consumption	3.0 A
Fuse protection, external, per valve	3.15 A (slow-blowing)
Power consumption of motor in neutral position	9.6 W (0.4 A at 24 V DC)
Maximum power consumption	55.2 W (2.3 A at 24 V DC)
EM compatibility	Emitted interference as per EN 61000-6-4:2005, (CANopen® and Profibus-DP®); Emitted interference as per EN 61000-6-3:2005, (EtherCAT®); Immunity to interference as per EN 61000-6-2:2005, (evaluation criterion A);
Connector type	See Electronics section
Triggering electronics	Integrated in the valve, see Electronics section

Characteristic curves (typical) ¹⁾

STEP RESPONSE 60 L/MIN (15.9 GPM) VERSION

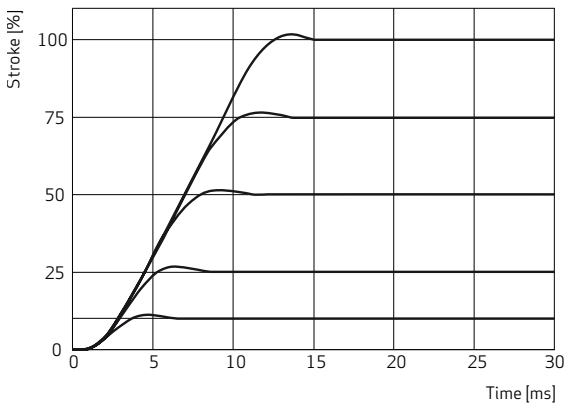

STEP RESPONSE 100 L/MIN (26.4 GPM) VERSION

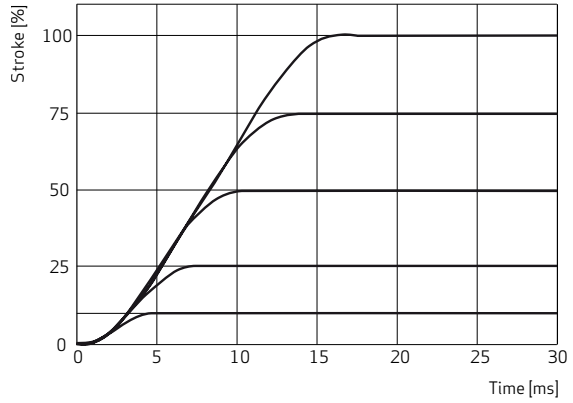

FREQUENCY RESPONSE 60 L/MIN (15.9 GPM) VERSION

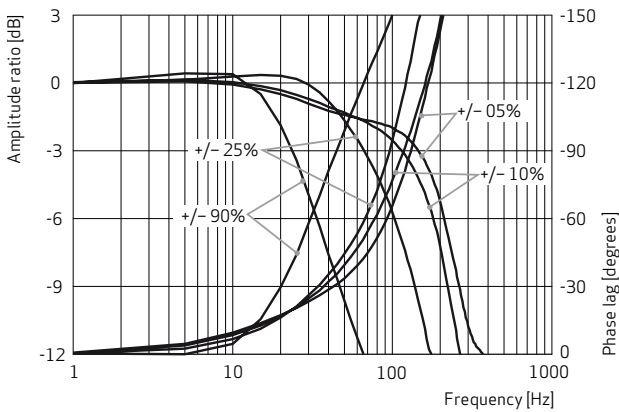

FREQUENCY RESPONSE 100 L/MIN (26.4 GPM) VERSION

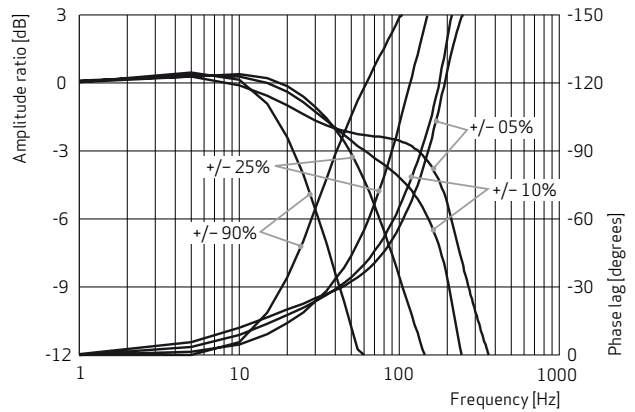

PRESSURE CHARACTERISTIC CURVE
(valve with zero lap)

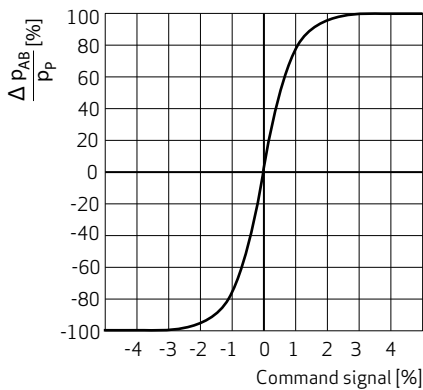

FLOW SIGNAL CHARACTERISTIC CURVE
(valve with zero lap)

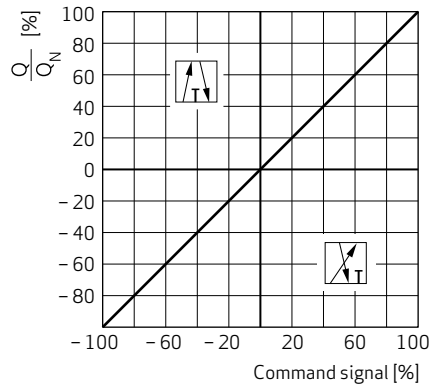

¹⁾ At operating pressure $p_p = 140$ bar (2,000 psi), fluid viscosity $\nu = 32$ mm²/s (cSt) and a fluid temperature of 40 °C (104 °F)

INSTALLATION DRAWINGS FOR VALVES WITH CANOPEN FIELDBUS CONNECTOR

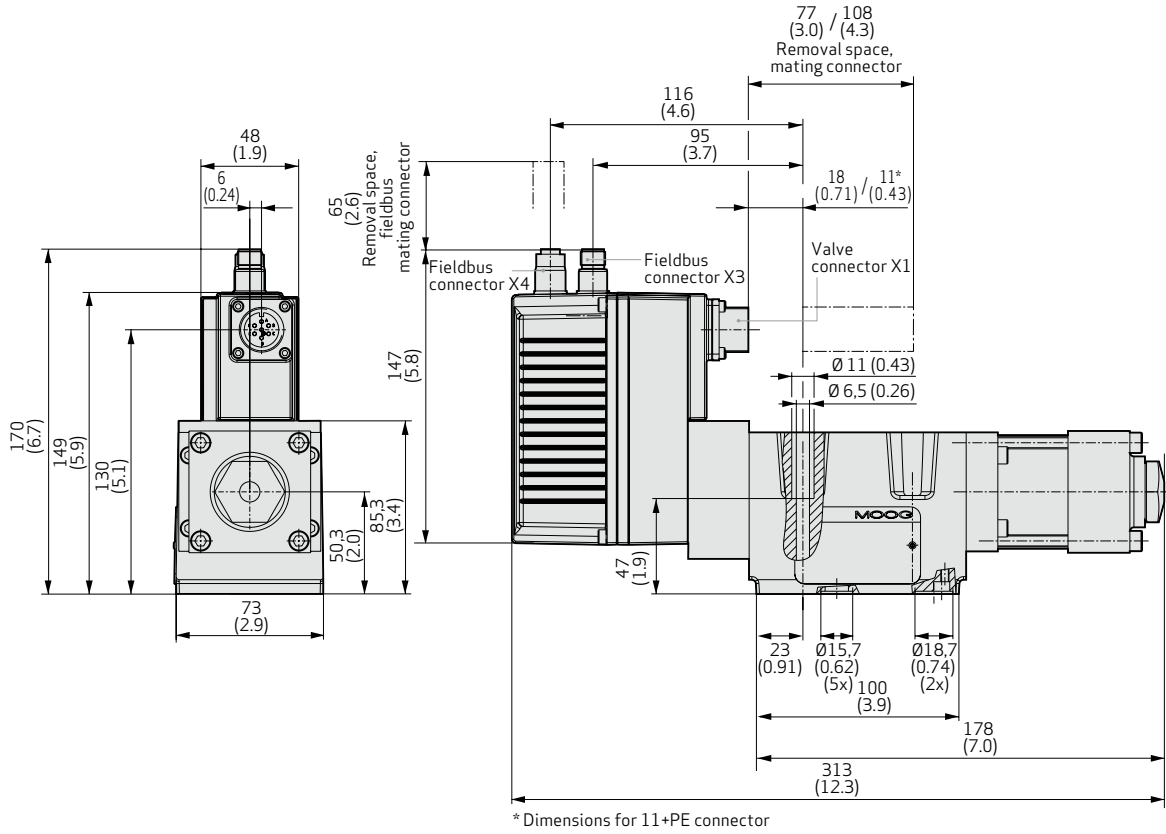

INSTALLATION DRAWINGS FOR VALVES WITH PROFIBUS-DP OR ETHERCAT FIELDBUS CONNECTOR

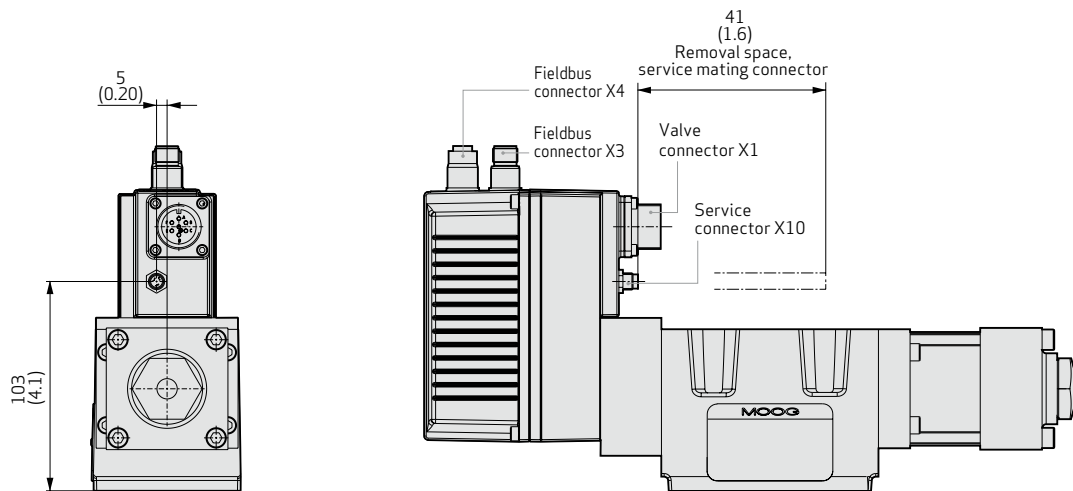

INSTALLATION DRAWINGS FOR VALVES WITH ANALOG ACTIVATION

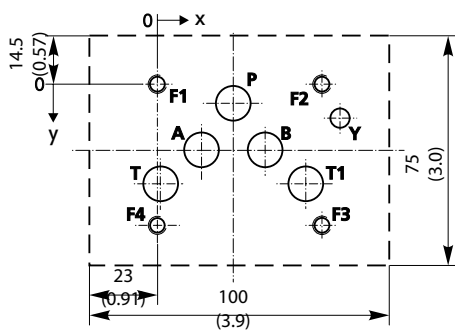
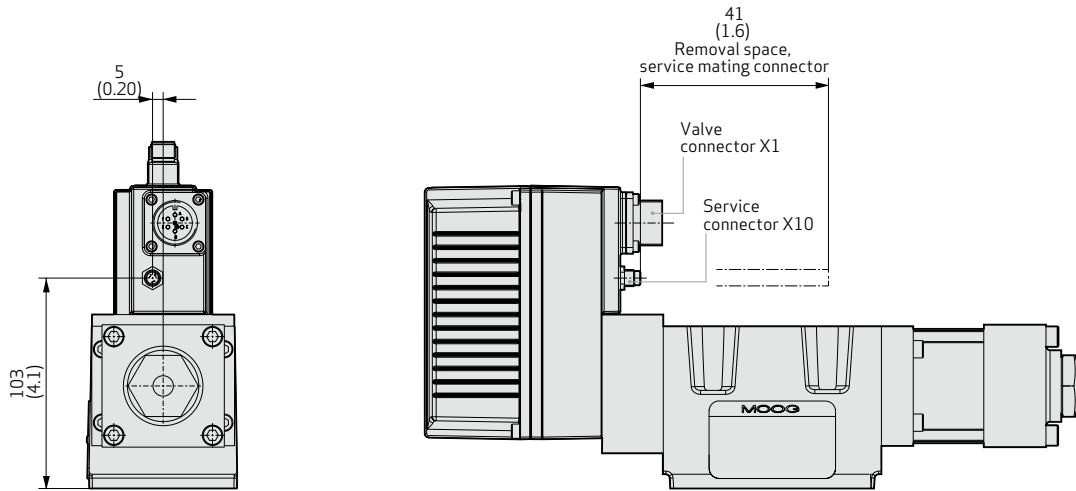

Mounting pattern of mounting surface

(ISO 4401-05-05-0-05 without X port)
 Flatness of mounting surface < 0.01 mm (0.0004 in)
 over 100 mm (3.94 in), average surface finish
 $R_a = 0.8 \mu\text{m}$ (0.0000314 in)



	P	A	B	T	T ₁	X ¹⁾	Y	F ₁	F ₂	F ₃	F ₄
	Ø 11.2 (0.44)	Ø 11.2 (0.44)	Ø 11.2 (0.44)	Ø 11.2 (0.44)	Ø 11.2 (0.44)		Ø 6.3 (0.25)	M6	M6	M6	M6
X	27 (1.06)	16.7 (0.66)	37.3 (1.47)	3.2 (0.13)	50.8 (2.00)		62 (2.44)	0	54 (2.13)	54 (2.13)	0
Y	6.3 (0.25)	21.4 (0.84)	21.4 (0.84)	32.5 (1.28)	32.5 (1.28)		11 (0.43)	0	0	46 (1.81)	46 (1.81)

¹⁾ Do not drill port X, as not sealed in the valve.

D637 - Spare parts

Part designation	Description	Part number
Shipping plate		A40503
O-rings for ports P, T ₁ , A, B (5 rings per valve required)	ID 12.4 x Ø 1.8: NBR 90 Shore (ID 0.5 x Ø 0.07)	-45122-004
O-ring for ports P, T ₁ , A, B (5 rings per valve required)	ID 12.4 x Ø 1.8: FKM 90 Shore (ID 0.5 x Ø 0.07)	-42082-004
O-ring for port Y	ID 15.6 Ø 1.8: NBR 90 Shore (ID 0.61 x Ø 0.07)	-45122-011
O-ring for port Y	ID 15.6 Ø 1.8: FKM 90 Shore (ID 0.61 x Ø 0.07)	-42082-011

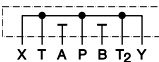
D637 - Accessories

Part designation	Description	Part number
Service sealing kit with O-rings for ports P, T, T ₁ , A, B, Y	NBR 90 Shore	B97215-N681-10
Service sealing kit with O-rings for ports P, T, T ₁ , A, B, Y	FKM 90 Shore	B97215-V681-10
Installation screws of servovalve (4 screws per valve required)	M6x60, ISO 4762-10.9 tightening torque 11 Nm (97 in-lbs)	A03665-060-060
Flushing plate for P, A, B, T, T ₁ , X, Y		B67728-001
Flushing plate for P, A, B, T, T ₁ , X, Y		B67728-002
Flushing plate for P, A, B, T, T ₁ , X, Y		B67728-003

D637 - Documents

Designation	Description	Part number
Manual D637 Series Servovalves	Operating instructions	Upon request ¹⁾

¹⁾ Download the document at www.moog.com/industrial/literature

D636 and D637 - Accessories

Part designation	Description	Part number
Dust protection cap for fieldbus connector with external thread X3	Required for operation without mating connector (IP protection)	C55823-001
Dust protection cap for fieldbus connector with internal thread X4	Required for operation without mating connector (IP protection)	CA24141-001
Mating connector for 6-pole + PE connector, IP65	EN 175201-804, usable cable with minimum \varnothing 10 mm (0.394 in), maximum \varnothing 12 mm (0.472 in)	B97007-061
Mating connector for 11-pole + PE connector, IP65	EN 175201-804, usable cable with minimum \varnothing 11 mm (0.433 in), maximum \varnothing 13 mm (0.512 in)	B97067-111
6-pole + PE cable (3 m (9.7 ft))		C21033-003-001
11-pole + PE cable (3 m (9.7 ft))		C21031-003-001
Configuration / commissioning software		Upon request
USB starting-up module		C43094--001
Configuration / starting-up cable (2 m (6.4 ft))		TD3999-137
Adapter for M8 service connector	Configuration /starting-up cable TD3999-137 is also required	CA40934-001
SELV power pack (10 A, 24 V DC)		D137-003-001
Power supply cable (2 m (6.4 ft))		B95924-002

D636 and D637 - Documents

Designation	Description	Part number
Technical Note TN 353	Protective grounding and electrical shielding of hydraulic valves with integrated electronics	CA58437-001 ¹⁾
Technical Note TN 494	Permissible cable lengths for connecting hydraulic valves with integrated electronics	CA48851-001 ¹⁾

¹⁾ Download the document at www.moog.com/industrial/literature

Moog Global Support™ is our promise to offer world-class Repair and Maintenance Services delivered expertly by our trained technicians. With the reliability only available from a leading manufacturer with facilities around the world, Moog offers you service and expertise you can count on to keep your equipment operating as it should.

This promise offers many benefits to our customers including:

- Reduce your downtime by keeping critical machines running in peak performance
- Protect your investment by ensuring reliability, versatility and long-life of products
- Better plan your maintenance activities and make systematic upgrades
- Leverage our flexible programs to meet unique service requirements of your facility

Look to Moog for global support including:

- Repair services using OEM parts are performed by trained technicians to the latest specifications
- Stock management of spare parts and products to prevent unplanned downtime
- Flexible programs, tailored to your needs such as upgrades, preventative maintenance and annual/multi-year contracts
- On-site services bring the expertise to you, providing quicker commissioning, set-up and diagnostics
- Access to reliable services that are guaranteed to offer consistent quality anywhere in the world

For more information on Moog Global Support™, visit www.moog.com/industrial/service.



Model number (established by factory)

D 636 -

Specification status	
-	Series specification
Z	Special specification

Model designation

Factory identification

Variant

1 Valve type
R Servovalve with integrated digital electronics

2 Rated flow Q_N per spool land [l/min (gpm)]	
$\Delta p_N = 35 \text{ bar (500 psi)}$	$\Delta p_N = 5 \text{ bar (75 psi)}$
02 5 (1.3)	2 (0.53)
04 10 (2.6)	4 (1.1)
08 20 (5.3)	8 (2.1)
16 40 (10.6)	16 (4.2)

3 Maximum operating pressure [bar (psi)]
K 350 (5,000)

4 Bushing / spool design
O 4-way; zero lap, linear characteristic curve
A 4-way; 1.5 to 3 % positive overlap, linear characteristic curve
D 4-way; 10 % positive overlap, linear characteristic curve
Z 2x2-way; P→A, B→T, only with Y port
X Special spool, upon request

5 Linear force motor	Series
1 Standard	D636

6 Spool position without electrical supply
M Mid position ¹⁾
F P→B, A→T connected (approximately 10 % open)
D P→A, B→T connected (approximately 10 % open)

- Options sometimes only for an additional charge.
- Not all combination options available.
- Preferred versions are marked in gray.

Type designation

1 2 3 4 5 6 7 8 9 10 11 12 13 14 15 16
 - **A1**

15 Service connector X10
O1 Without ⁴⁾
K1 With ⁵⁾

14 Field bus connector X3, X4
C CANopen
D Profibus-DP ³⁾
E EtherCAT ³⁾
O Without ³⁾

13 Enable function
A When the enable signal is deactivated the spool takes up a presettable controlled neutral position.
B Linear force motor without enable signal de-energized.
K⁶⁾ When the enable signal is deactivated the spool takes up a presettable controlled neutral position. Spool position monitoring at pin 11.
L⁶⁾ Linear force motor without enable de-energized. Spool position monitoring at pin 11.
Others upon request.

11 Supply voltage
2 24 V DC (18 to 32 V DC)

10 Signals for 100 % spool stroke (dead band compensation upon request)	
Input signal	Measurement output
M ±10 V DC	4 to 20 mA
X ±10 mA	4 to 20 mA
E 4 to 20 mA	4 to 20 mA
9 Field bus digital ²⁾	4 to 20 mA

9 Valve connector X1
S 6-pole + PE EN 175201-804
E 11-pole + PE EN 175201-804

8 Seal material
H HNBR
V FKM
Others upon request

7 Y port
0 Closed with screw cap $P_{Tmax} = 50 \text{ bar (725 psi)}$
3 Open, with filter element $P_{Tmax} > 50 \text{ bar (725 psi)}$

¹⁾ This does not correspond with bushing / spool design O, A to the hydraulic center position

²⁾ Only in conjunction with field bus connector "C, D, E" (changeover to analog signals „M, X, E“ possible)

³⁾ Valve parameterization with commissioning software „Moog Valve Configuration Software“ using M8 service connector

⁴⁾ Only in conjunction with field bus connector "C"

⁵⁾ Only in conjunction with field bus connector "D, E, O"

⁶⁾ Only in conjunction with connector "E"

Model number (established by factory)

D 637 -

Type designation

1 2 3 4 5 6 7 8 9 10 11 12 13 14 15 16
 - **A1**

Specification status	
-	Series specification
Z	Special specification

Model designation

Factory identification

Variant

1 Valve type
R Servovalve with integrated digital electronics

2 Rated flow Q_N per spool land [l/min (gpm)]	
$\Delta p_N = 35 \text{ bar (500 psi)}$	$\Delta p_N = 5 \text{ bar (75 psi)}$
24 60 (15.9)	24 (6.3)
40 100 (26.4)	40 (10.6)

3 Maximum operating pressure [bar (psi)]	
K	350 (5,000)

4 Bushing / spool design	
O	4-way: zero lap, linear characteristic curve
A	4-way: 1.5 to 3 % positive overlap, linear characteristic curve
D	4-way: 10 % positive overlap, linear characteristic curve
Z	2x2-way: P→A, B→T, only with Y port
X	Special spool, upon request

5 Linear force motor	Series
2 Standard	D637

6 Spool position without electrical supply	
M	Center position ¹⁾
F	P→B, A→T connected (approximately 10 % open)
D	P→A, B→T connected (approximately 10 % open)

15 Service connector X10	
O1	Without ⁴⁾
K1	With ⁵⁾

14 Field bus connector X3, X4	
C	CANopen
D	Profibus-DP ³⁾
E	EtherCAT ³⁾
O	Without ³⁾

13 Enable function	
A	When the enable signal is deactivated the spool takes up a settable controlled neutral position.
B	Linear force motor without enable signal de-energized.
K⁶⁾	When the enable signal is deactivated the spool takes up a settable controlled neutral position. Spool position monitoring at pin 11.
L⁶⁾	Linear force motor without enable de-energized. Spool position monitoring at pin 11.
	Others upon request.

11 Supply voltage	
2	24 V DC (18 to 32 V DC)

10 Signals for flow Q and pressure p		
	Input signal	Measurement output
M	±10 V	4 to 20 mA
X	±10 mA	4 to 20 mA
E	4 to 20 mA	4 to 20 mA
9	Field bus digital ²⁾	4 to 20 mA
Actual value output		Spool position 4 to 20 mA

9 Valve connector X1	
S	6-pole + PE EN 175201-804
E	11-pole + PE EN 175201-804

8 Seal material	
N	NBR
V	FKM
	Others upon request.

7 Y port		
0	Closed with screw cap	$P_{Tmax} = 50 \text{ bar (725 psi)}$
3	Open, with filter element	$P_T > 50 \text{ bar (725 psi)}$

- Options sometimes only for an additional charge.
- Not all combination options available.
- Preferred versions are marked in gray.

¹⁾ This does not correspond with bushing / spool design O, A to the hydraulic center position
²⁾ Only in conjunction with field bus connector "C, D, E" (changeover to analog signals „M, X, E" possible)

³⁾ Valve parameterization with commissioning software „Moog Valve Configuration Software" via M8 service connector
⁴⁾ Only in conjunction with field bus connector "C"
⁵⁾ Only in conjunction with field bus connector "D, E, O"
⁶⁾ Only in conjunction with connector "E"

TAKE A CLOSER LOOK.

Moog designs a range of motion control products that complement the performance of those featured in this catalog. Visit our website for more information and contact the Moog facility nearest you.

Argentina
+54 11 4326 5916
info.argentina@moog.com

India
+91 80 4057 6605
info.india@moog.com

Singapore
+65 677 36238
info.singapore@moog.com

Australia
+61 3 9561 6044
info.australia@moog.com

Ireland
+353 21 451 9000
info.ireland@moog.com

South Africa
+27 12 653 6768
info.southafrica@moog.com

Brazil
+55 11 3572 0400
info.brazil@moog.com

Italy
+39 0332 421 111
info.italy@moog.com

Spain
+34 902 133 240
info.spain@moog.com

Canada
+1 716 652 2000
info.canada@moog.com

Japan
+81 46 355 3767
info.japan@moog.com

Sweden
+46 31 680 060
info.sweden@moog.com

China
+86 21 2893 1600
info.china@moog.com

Korea
+82 31 764 6711
info.korea@moog.com

Switzerland
+41 71 394 5010
info.switzerland@moog.com

Finland
+358 10 422 1840
info.finland@moog.com

Luxembourg
+352 40 46 401
info.luxembourg@moog.com

United Kingdom
+44 168 429 6600
info.uk@moog.com

France
+33 1 4560 7000
info.france@moog.com

The Netherlands
+31 252 462 000
info.thenetherlands@moog.com

USA
+1 716 652 2000
info.usa@moog.com

Germany
+49 7031 622 0
info.germany@moog.com

Norway
+47 6494 1948
info.norway@moog.com

Hong Kong
+852 2 635 3200
info.hongkong@moog.com

Russia
+7 831 713 1811
info.russia@moog.com

www.moog.com/industrial

Moog is a registered trademark of Moog Inc. and its subsidiaries. All trademarks as indicated herein are the property of Moog Inc. and its subsidiaries.

CANopen is a registered trademark of CAN in Automation (CiA)

EtherCAT is a registered trademark of Beckhoff Automation GmbH

Profibus-DP is a registered trademark of PROFIBUS Nutzerorganisation e.V.

Windows and Vista are registered trademarks of Microsoft Corporation

©2010 Moog Inc.

D636 and D637 Series Servovalves
Moog Germany/PDF/Rev. 2, March 2010, Id. CDL28329-en